



OPEN Industry Standard, Flexible Architecture

GREEN Less Heat, Less Power Consumption

STABLE Robust Design, Quality Parts

Stable and
Reliable Solution

Server/Workstation
Motherboard

EPC621D6U
EPC621D6U-16R
EPC621D6U-2T
EPC621D6U-2T16R

User Manual

English



Version 1.0

Published March 2019

Copyright©2019 ASRock Rack Inc. All rights reserved.

Copyright Notice:

No part of this documentation may be reproduced, transcribed, transmitted, or translated in any language, in any form or by any means, except duplication of documentation by the purchaser for backup purpose, without written consent of ASRock Rack Inc.

Products and corporate names appearing in this documentation may or may not be registered trademarks or copyrights of their respective companies, and are used only for identification or explanation and to the owners' benefit, without intent to infringe.

Disclaimer:

Specifications and information contained in this documentation are furnished for informational use only and subject to change without notice, and should not be constructed as a commitment by ASRock Rack. ASRock Rack assumes no responsibility for any errors or omissions that may appear in this documentation.

With respect to the contents of this documentation, ASRock Rack does not provide warranty of any kind, either expressed or implied, including but not limited to the implied warranties or conditions of merchantability or fitness for a particular purpose.

In no event shall ASRock Rack, its directors, officers, employees, or agents be liable for any indirect, special, incidental, or consequential damages (including damages for loss of profits, loss of business, loss of data, interruption of business and the like), even if ASRock Rack has been advised of the possibility of such damages arising from any defect or error in the documentation or product.



This device complies with Part 15 of the FCC Rules. Operation is subject to the following two conditions:

- (1) this device may not cause harmful interference, and
- (2) this device must accept any interference received, including interference that may cause undesired operation.

CALIFORNIA, USA ONLY

The Lithium battery adopted on this motherboard contains Perchlorate, a toxic substance controlled in Perchlorate Best Management Practices (BMP) regulations passed by the California Legislature. When you discard the Lithium battery in California, USA, please follow the related regulations in advance.

"Perchlorate Material-special handling may apply, see www.dtsc.ca.gov/hazardouswaste/perchlorate"

ASRock Rack's Website: www.ASRockRack.com

Contact Information

If you need to contact ASRock Rack or want to know more about ASRock Rack, you're welcome to visit ASRock Rack's website at www.ASRockRack.com; or you may contact your dealer for further information.

ASRock Rack Incorporation

6F., No.37, Sec. 2, Jhongyang S. Rd., Beitou District,

Taipei City 112, Taiwan (R.O.C.)

Contents

| | |
|---|-----------|
| Chapter 1 Introduction | 1 |
| 1.1 Package Contents | 1 |
| 1.2 Specifications | 2 |
| 1.3 Unique Features | 6 |
| 1.4 Motherboard Layout | 7 |
| 1.5 Onboard LED Indicators | 10 |
| 1.6 I/O Panel | 12 |
| 1.7 Block Diagram | 14 |
| Chapter 2 Installation | 15 |
| 2.1 Screw Holes | 15 |
| 2.2 Pre-installation Precautions | 15 |
| 2.3 Installing the CPU and Heatsink | 16 |
| 2.4 Installation of Memory Modules (DIMM) | 20 |
| 2.5 Expansion Slots (PCI Express Slots) | 21 |
| 2.6 Jumper Setup | 22 |
| 2.7 Onboard Headers and Connectors | 25 |
| 2.8 Unit Identification purpose LED/Switch | 32 |
| 2.9 Driver Installation Guide | 32 |
| 2.10 M.2_SSD (NGFF) Module Installation Guide | 33 |
| Chapter 3 UEFI Setup Utility | 35 |
| 3.1 Introduction | 35 |
| 3.1.1 UEFI Menu Bar | 35 |
| 3.1.2 Navigation Keys | 36 |

| | | |
|--------|---------------------------------|----|
| 3.2 | Main Screen | 37 |
| 3.3 | Advanced Screen | 38 |
| 3.3.1 | CPU Configuration | 39 |
| 3.3.2 | DRAM Configuration | 42 |
| 3.3.3 | Chipset Configuration | 43 |
| 3.3.4 | Storage Configuration | 46 |
| 3.3.5 | ACPI Configuration | 48 |
| 3.3.6 | USB Configuration | 49 |
| 3.3.7 | Super IO Configuration | 50 |
| 3.3.8 | Serial Port Console Redirection | 51 |
| 3.3.9 | H/W Monitor | 54 |
| 3.3.10 | Runtime Error Logging | 56 |
| 3.3.11 | Intel SPS Configuration | 58 |
| 3.3.12 | Intel® VMD Technology | 59 |
| 3.3.13 | Intel(R) Virtual RAID on CPU | 61 |
| 3.3.14 | Instant Flash | 62 |
| 3.4 | Security | 63 |
| 3.4.1 | Key Management | 64 |
| 3.5 | Boot Screen | 67 |
| 3.5.1 | CSM Parameters | 69 |
| 3.6 | Event Logs | 71 |
| 3.7 | Server Mgmt | 73 |
| 3.7.1 | System Event Log | 74 |
| 3.7.2 | BMC Network Configuration | 75 |

3.8 Exit Screen 77

Chapter 4 Software Support 78

4.1 Install Operating System 78

4.2 Support CD Information 78

4.2.1 Running The Support CD 78

4.2.2 Drivers Menu 78

4.2.3 Utilities Menu 78

4.2.4 Contact Information 78

Chapter 5 Troubleshooting 79

5.1 Troubleshooting Procedures 79

5.2 Technical Support Procedures 81

5.3 Returning Merchandise for Service 81

Chapter 1 Introduction

Thank you for purchasing ASRock Rack **EPC621D6U Series** motherboard, a reliable motherboard produced under ASRock Rack's consistently stringent quality control. It delivers excellent performance with robust design conforming to ASRock Rack's commitment to quality and endurance.

In this manual, chapter 1 and 2 contains introduction of the motherboard and step-by-step guide to the hardware installation. Chapter 3 and 4 contains the configuration guide to BIOS setup and information of the Support CD.



Because the motherboard specifications and the BIOS software might be updated, the content of this manual will be subject to change without notice. In case any modifications of this manual occur, the updated version will be available on ASRock Rack website without further notice. You may find the latest memory and CPU support lists on ASRock Rack website as well. ASRock Rack's Website: www.ASRockRack.com

*If you require technical support related to this motherboard, please visit our website for specific information about the model you are using.
<http://www.asrockrack.com/support/>*

1.1 Package Contents

- ASRock Rack EPC621D6U Series Motherboard
(micro-ATX Form Factor: 9.6-in x 9.6-in, 24.4 cm x 24.4 cm)
- 1 x SATA3 Cable (6G) (60cm)
- 1 x Mini SAS HD to 4 SAS/SATA Cable (12G)
- 1 x Screw for M.2 Socket
- 1 x I/O Shield
- Quick Installation Guide



If any items are missing or appear damaged, contact your authorized dealer.

1.2 Specifications

| EPC621D6U / EPC621D6U-16R / EPC621D6U-2T / EPC621D6U-2T16R | |
|--|--|
| MB Physical Status | |
| Form Factor | micro-ATX |
| Dimension | 9.6" x 9.6" (24.4 cm x 24.4 cm) |
| Processor System | |
| CPU | Intel® Xeon® Scalable Processors |
| Socket | Single Socket P (3647) |
| Chipset | Intel® C621 |
| System Memory | |
| Capacity | - 6 x 288-pin DDR4 DIMM slots - Support up to 64GB DDR4 RDIMM/LR DIMM/Apache Pass DIMM |
| Type | - Six Channel DDR4 memory technology - Support DDR4 2933*/2666/2400/2133 RDIMM/LR DIMM and Apache Pass DIMM <i>*DDR4 2933 memory is supported only when using the Intel Cascade Lake CPU and Intel Cascade Lake BIOS.</i> |
| DIMM Size Per DIMM | RDIMM/LR DIMM and Apache Pass DIMM: 64GB,32GB, 16GB, 8GB, 4GB |
| DIMM Frequency | RDIMM/LR DIMM and Apache Pass DIMM: 2933*/2666/2400/2133 MHz <i>*DDR4 2933 memory is supported only when using the Intel Cascade Lake CPU and Intel Cascade Lake BIOS.</i> |
| Voltage | 1.2V |
| Expansion Slot | |
| PCIe 3.0 x 16 | PCIe6: Gen3 x16 link PCIe4: Gen3 x16 link* <i>*EPC621D6U-16R / EPC621D6U-2T16R only: The SAS_NVMEA0_7 and SAS_NVMEB0_7 are shared with the PCIe4 slot. When PCIe4 is populated with a PCIe card, SAS_NVMEA0_7 and SAS_NVMEB0_7 are disabled.</i> |
| Storage | |
| SATA Controller | EPC621D6U / EPC621D6U-2T: 14 x SATA3 6Gb/s (including 1 x SATA DOM port (SSATA_5), shared with M.2 (PCIe3.0(x4))/ SATA3)), 3 x MiniSAS HD connectors (SATA_0_3 / SATA_0_7), and 1 x SATA port (SSATA_4), support RAID 0, 1, 5, 10 EPC621D6U-16R / EPC621D6U-2T16R: 30 x SATA3 6Gb/s (including 1 x SATA DOM port (SSATA_5), shared with M.2 (PCIe3.0(x4))/ SATA3)), 7 x MiniSAS HD connectors (SATA_0_3 / SATA_0_7 / SAS_NVMEA0_7 / SAS_NVMEB0_7), and 1 x SATA port (SSATA_4)), support RAID 0, 1, 5, 10 |

| | |
|-------------------------------|--|
| Additional Storage Controller | EPC621D6U / EPC621D6U-2T: N/A EPC621D6U-16R / EPC621D6U-2T16R: LSI3616 (shared with PCIE Slot4) |
| U.2 from Slimline | 1 (Slimline x8 from CPU1) |
| Ethernet | |
| Interface | EPC621D6U / EPC621D6U-16R: 1000 /100 /10 Mbps EPC621D6U-2T / EPC621D6U-2T16R: 10000/1000 /100 Mbps |
| LAN | EPC621D6U / EPC621D6U-16R: - 2 x RJ45 1G base-T by Intel® i350 - 1 x RJ45 Dedicated IPMI LAN port by RTL8211E EPC621D6U-2T / EPC621D6U-2T16R: - 2 x RJ45 10G base-T by Intel® X550 - 1 x RJ45 Dedicated IPMI LAN port by RTL8211E - Supports Wake-On-LAN - Supports Energy Efficient Ethernet 802.3az - Supports Dual LAN with Teaming function(TBD) - Supports PXE - LAN1 supports NCSI |
| Management | |
| BMC Controller | ASPEED AST2500 |
| IPMI Dedicated GLAN | 1 x Realtek RTL8211E for dedicated management GLAN |
| Features | Watch Dog NMI |
| Graphics | |
| Controller | ASPEED AST2500 |
| VRAM | DDR4 256MB |
| Rear Panel I/O | |
| VGA Port | 1 x D-Sub |
| UID Button | 1 |
| USB 3.0 Port | 2 |
| LAN Port | - 2 + 1 x RJ45 Gigabit Ethernet LAN port - LAN Ports with LED (ACT/LINK LED and SPEED LED) |
| Internal Connector | |
| Auxiliary Panel Header | 1 (includes chassis intrusion, location button & LED, front LAN LED) |
| TPM Header | 1 |

| | |
|-------------------------|---|
| IPMB Header | 1 |
| Buzzer | 1 |
| Fan Header | 6 Fans x (6-pin) (CPU/4Front/Rear) |
| ATX Power | 1 (24-pin) + 1 (8-pin) |
| USB 3.0 Header | 1 (supports 2 USB 3.0 ports) |
| USB 2.0 Header | 1 (supports 2 USB 2.0 ports) |
| Type A USB 3.0 | 1 |
| SATA DOM | 1 (SSATA_5, shared with M.2) |
| COM Port Header | 1 |
| 80 debug port LED | 1 |
| Front Panel | 1 (RST, PWRBTN, HDDLED, PWRLED) |
| Speaker | 1 (4pin) |
| TR1 | 1 |
| SGPIO | 1 |
| Smbus from BMC | 1 |
| PWR_SMB | 1 |
| M.2 | 1 (2230/2242/2260/2280), supports PCIE3.0(X4)/SATA3 (SATA type is shared with SSATA_5) |
| NMI Button | 1 (Header) |
| ME/SPS recovery | 1 |
| ClearCMOS | 1 (short pin) |
| OH/FanFail LED | 6 (only Fan Fail LED) |
| System BIOS | |
| BIOS Type | 256Mb AMI UEFI Legal BIOS |
| BIOS Features | - Plug and Play (PnP) - ACPI 2.0 Compliance Wake Up Events - SMBIOS 2.8 Support - ASRock Rack Instant Flash |
| Hardware Monitor | |
| Temperature | - CPU Temperature Sensing - SystemTemperature Sensing |
| Fan | - CPU/Rear/Front Fan Tachometer - CPU Quiet Fan (Allow Chassis Fan Speed Auto-Adjust by CPU Temperature) - CPU/Rear/Front Fan Multi-Speed Control |
| Voltage | Voltage Monitoring: +12V, +5V, +3.3V, CPU Vcore, DRAM, 1.05V_PCH, +BAT, 3VSB, 5VSB |

Support OS

| | |
|----|--|
| OS | <p>Microsoft® Windows® (Server OS)</p> <ul style="list-style-type: none"> - Server 2012 R2 (64 bit) - Server 2016 (64 bit) <p>Linux®</p> <ul style="list-style-type: none"> - Red Hat Enterprise Linux Server 6.8 (64 bit) / 7.4 (64 bit) - CentOS 6.8 (64 bit) / 7.4 (64 bit) - SUSE Enterprise Linux Server 11 SP4 (64 bit) / 12 SP3 (64 bit) - FreeBSD 11.2 (64 bit) - Ubuntu 16.04 (64 bit) / 15.10 (64 bit) <p>Virtual</p> <ul style="list-style-type: none"> - VMWare® ESXi 6.5 u1 - Citrix XenServer 7.5 - Win hyper-V Server 2016 <p><i>*Please refer to our website for the latest OS support list.</i></p> <p><i>*On Ubuntu 16.04 (64bit) system, Intel Raid mode only supports UEFI BOOT.</i></p> <p><i>*LSI does not support Vmware ESXi 6.5 u1 / Ubuntu 16.04 (64 Bit) / Ubuntu 15.10 (64 Bit) / Citrix XenServer 7.5 OS install.</i></p> |
|----|--|

Environment

| | |
|-------------|---|
| Temperature | <p>Operation temperature: 10°C ~ 35°C / Non operation temperature: -40°C ~ 70°C</p> |
|-------------|---|

NOTE: Please refer to our website for the latest specifications.



This motherboard supports Wake from on Board LAN. To use this function, please make sure that the "Wake on Magic Packet from power off state" is enabled in Device Manager > Intel® Ethernet Connection > Power Management. And the "PCI Devices Power On" is enabled in UEFI SETUP UTILITY > Advanced > ACPI Configuration. After that, onboard LAN1&2 can wake up S5 under OS.



If you install Intel® LAN utility or Marvell SATA utility, this motherboard may fail Windows® Hardware Quality Lab (WHQL) certification tests. If you install the drivers only, it will pass the WHQL tests.

1.3 Unique Features

ASRock Rack Instant Flash is a BIOS flash utility embedded in Flash ROM. This convenient BIOS update tool allows you to update system BIOS without entering operating systems first like MS-DOS or Windows. With this utility, you can press the <F6> key during the POST or the <F2> key to enter into the BIOS setup menu to access ASRock Rack Instant Flash. Just launch this tool and save the new BIOS file to your USB flash drive, floppy disk or hard drive, then you can update your BIOS only in a few clicks without preparing an additional floppy diskette or other complicated flash utility. Please be noted that the USB flash drive or hard drive must use FAT32/16/12 file system.

1.4 Motherboard Layout

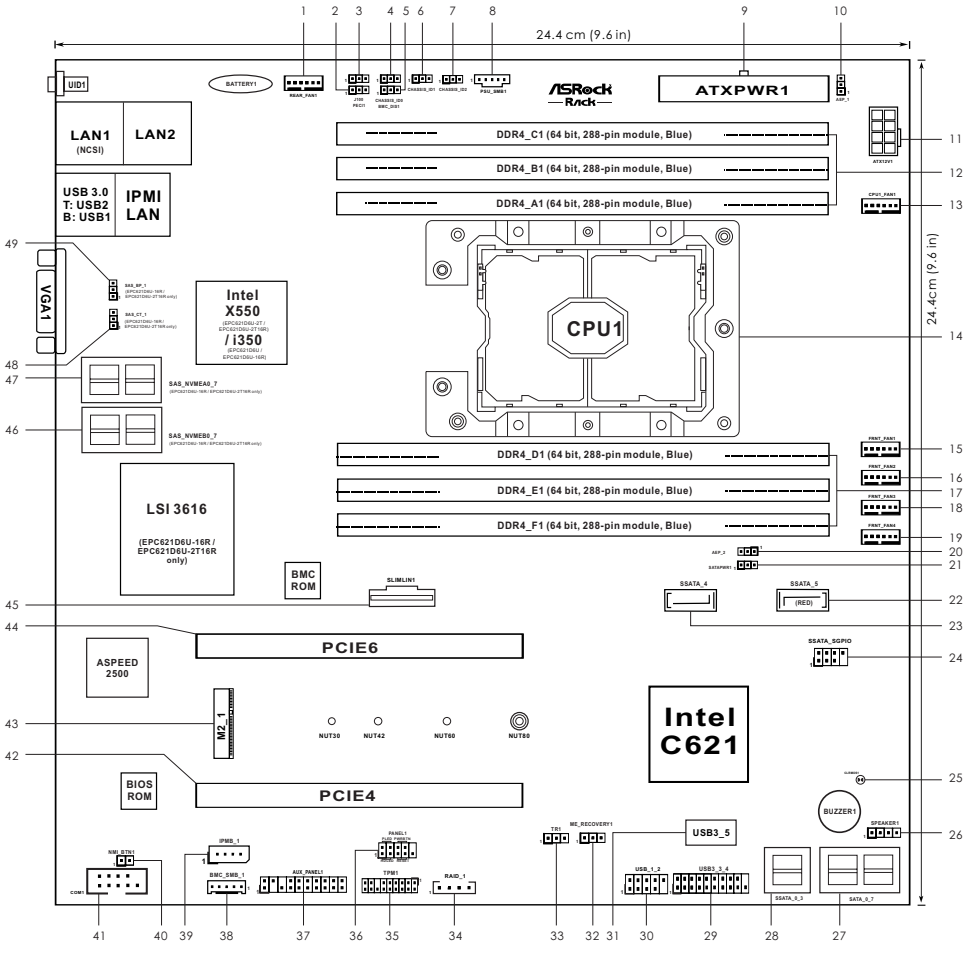

| No. | Description |
|-----|--|
| 1 | Rear Fan Connector (REAR_FAN1) |
| 2 | CPU PECl Mode Jumper (PECl1) |
| 3 | Descriptor Security Override Jumper (J100) |
| 4 | Chassis ID0 Jumper (CHASSIS_ID0) |
| 5 | Enable/Disable BMC Jumper (BMC_DIS1) |
| 6 | Chassis ID1 Jumper (CHASSIS_ID1) |
| 7 | Chassis ID2 Jumper (CHASSIS_ID2) |
| 8 | PSU SMBus (PSU_SMB1) |
| 9 | ATX Power Connector (ATXPWR1) |
| 10 | DIMM Mode Jumper (AEP_1) |
| 11 | ATX 12V Power Connector (ATX12V1) |
| 12 | 3 x 288-pin DDR4 DIMM Slots (DDR4_A1, DDR4_B1, DDR4_C1, Blue)* |
| 13 | CPU1 Fan Connector (CPU1_FAN1) |
| 14 | LGA 3647 CPU Socket P (CPU1) |
| 15 | Front Fan Connector (FRNT_FAN1) |
| 16 | Front Fan Connector (FRNT_FAN2) |
| 17 | 3 x 288-pin DDR4 DIMM Slots (DDR4_D1, DDR4_E1, DDR4_F1, Blue)* |
| 18 | Front Fan Connector (FRNT_FAN3) |
| 19 | Front Fan Connector (FRNT_FAN4) |
| 20 | DIMM Mode Jumper (AEP_2) |
| 21 | SATA DOM Power Jumper (SATAPWR1) |
| 22 | SATA DOM Connector, Red (SSATA_5)** |
| 23 | SATA3 Connector (SSATA_4)** |
| 24 | SATA SGPIO Connector (SSATA_SGPIO) |
| 25 | Clear CMOS Pad (CLRMOS1) |
| 26 | Speaker Header (SPEAKER1) |
| 27 | Mini-SAS HD Connector (SATA_0_7) |
| 28 | Mini-SAS HD Connector (SSATA_0_3)** |
| 29 | USB 3.0 Header (USB3_3_4) |
| 30 | USB 2.0 Header (USB_1_2) |
| 31 | Vertical Type A USB 3.0 (USB3_5) |
| 32 | ME Recovery Jumper (ME_RECOVERY1) |
| 33 | Thermal Sensor Header (TR1) |

| No. | Description |
|-----|--|
| 34 | Virtual RAID On CPU Header (RAID_1) |
| 35 | TPM Header (TPM1) |
| 36 | System Panel Header (PANEL1) |
| 37 | Auxiliary Panel Header (AUX_PANEL1) |
| 38 | BMC SMBus Header (BMC_SMB_1) |
| 39 | Intelligent Platform Management Bus Header (IPMB_1) |
| 40 | Non Maskable Interrupt Button (NMI_BTN1) |
| 41 | Serial Port Header (COM1) |
| 42 | PCI Express 3.0 Slot (PCIE4) |
| 43 | M.2 Slot (M2_1) (Type 2230 / 2242 / 2260 / 2280) |
| 44 | PCI Express 3.0 Slot (PCIE6) |
| 45 | Slimline for U.2 x8 Connector (SLIMLIN1) |
| 46 | Mini-SAS HD Connector (NVME) (SAS_NVMEB0_7) (EPC621D6U-16R / EPC621D6U-2T16R only) |
| 47 | Mini-SAS HD Connector (NVME) (SAS_NVMEA0_7) (EPC621D6U-16R / EPC621D6U-2T16R only) |
| 48 | SATA/SAS and NVMe Mode Selection Jumper (SAS_CT_1) (EPC621D6U-16R / EPC621D6U-2T16R only) |
| 49 | SATA/SAS and NVMe Mode Selection Jumper (SAS_BP_1) (EPC621D6U-16R / EPC621D6U-2T16R only) |

*For DIMM installation and configuration instructions, please see p.20 (Installation of Memory Modules (DIMM)) for more details.

** The first "S" of the "SSATA" means "secondary". SATA is managed by the first controller. SSATA is managed by the secondary controller.

1.5 Onboard LED Indicators

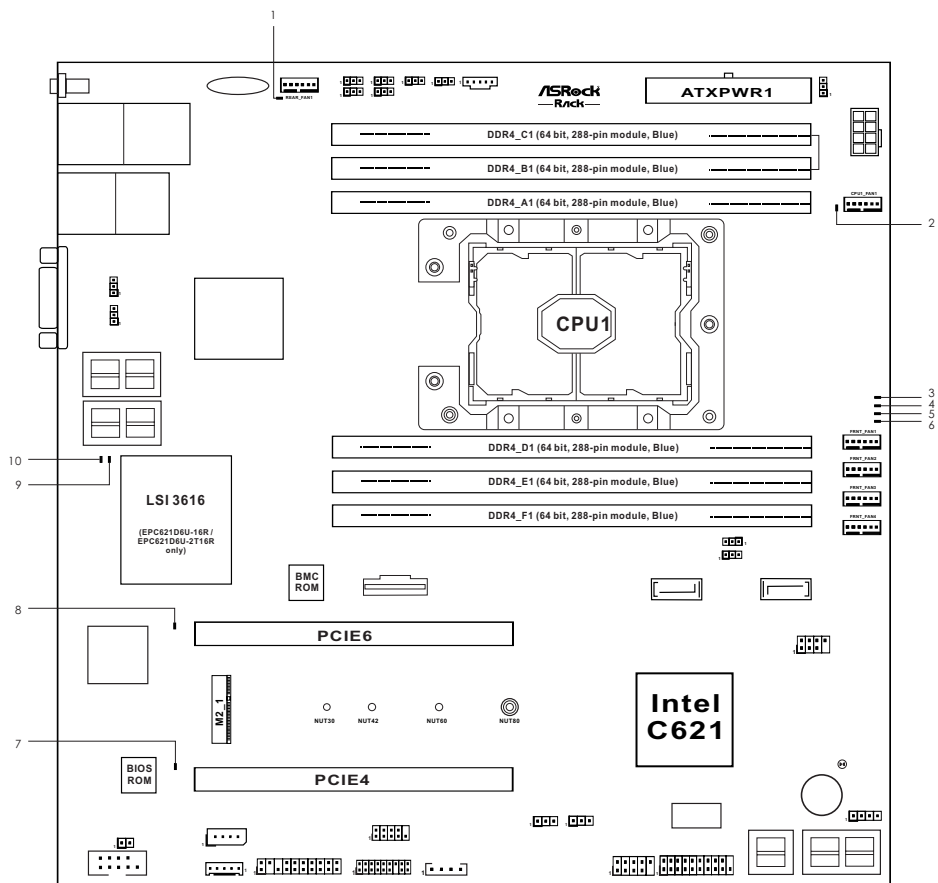

| No. | Item | Status | Description |
|-----|--------------|--------|---|
| 1 | RFAN_LED1 | Amber | Rear_FAN1 failed |
| 2 | CPU_FAN_LED1 | Amber | CPU1_FAN failed |
| 3 | FFAN_LED1 | Amber | FRNT_FAN1 failed |
| 4 | FFAN_LED2 | Amber | FRNT_FAN2 failed |
| 5 | FFAN_LED3 | Amber | FRNT_FAN3 failed |
| 6 | FFAN_LED4 | Amber | FRNT_FAN4 failed |
| 7 | SB_PWR1 | Green | STB PWR ready |
| 8 | BMC_LED1 | Green | BMC heartbeat LED |
| 9 | SAS_SYS_LED1 | Green | System Heartbeat LED <i>(EPC621D6U-16R / EPC621D6U-2T16R only)</i> |
| 10 | SAS_IOC_LED1 | Red | IOC Overtemp LED <i>(EPC621D6U-16R / EPC621D6U-2T16R only)</i> |

1.6 I/O Panel

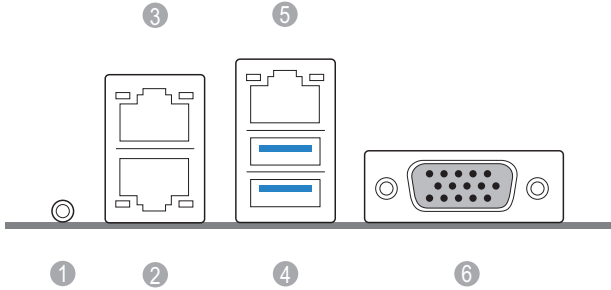

| No. | Description | No. | Description |
|-----|------------------------|-----|-----------------------------|
| 1 | UID Switch (UID) | 4 | USB 3.0 Ports (USB3_1_2) |
| 2 | LAN RJ-45 Port (LAN1)* | 5 | LAN RJ-45 Port (IPMI_LAN1)* |
| 3 | LAN RJ-45 Port (LAN2)* | 6 | VGA Port (VGA1) |

*There are two LED next to the LAN port. Please refer to the table below for the LAN port LED indications.

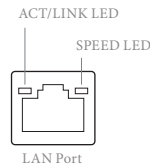

Dedicated IPMI LAN Port LED Indications

| Activity / Link LED | | Speed LED | |
|---------------------|---------------|-----------|-------------------------------|
| Status | Description | Status | Description |
| Off | No Link | Off | 10M bps connection or no link |
| Blinking Yellow | Data Activity | Yellow | 100M bps connection |
| On | Link | Green | 1Gbps connection |

**There are two LEDs on each LAN port. Please refer to the table below for the LAN port LED indications.

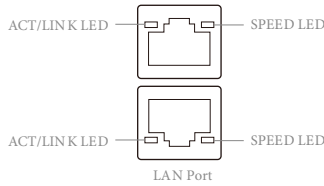

LAN Port (LAN1, LAN2) LED Indications

EPC621D6U / EPC621D6U-16R:

| Activity / Link LED | | Speed LED | |
|---------------------|---------------|-----------|------------------------------|
| Status | Description | Status | Description |
| Off | No Link | Off | 10Mbps connection or no link |
| Blinking Yellow | Data Activity | Yellow | 100Mbps connection |
| On | Link | Green | 1Gbps connection |

EPC621D6U-2T / EPC621D6U-2T16R:

| Activity / Link LED | | Speed LED | |
|---------------------|---------------|-----------|-------------------------------|
| Status | Description | Status | Description |
| Off | No Link | Off | 100Mbps connection or no link |
| Blinking Yellow | Data Activity | Yellow | 1Gbps connection |
| On | Link | Green | 10Gbps connection |

Chapter 2 Installation

This is a micro-ATX form factor (9.6" x 9.6", 24.4 cm x 24.4 cm) motherboard. Before you install the motherboard, study the configuration of your chassis to ensure that the motherboard fits into it.



Make sure to unplug the power cord before installing or removing the motherboard. Failure to do so may cause physical injuries to you and damages to motherboard components.

2.1 Screw Holes

Place screws into the holes indicated by circles to secure the motherboard to the chassis.

2.2 Pre-installation Precautions

Take note of the following precautions before you install motherboard components or change any motherboard settings.

1. Unplug the power cord from the wall socket before touching any components.
2. To avoid damaging the motherboard's components due to static electricity, NEVER place your motherboard directly on the carpet or the like. Also remember to use a grounded wrist strap or touch a safety grounded object before you handle the components.
3. Hold components by the edges and do not touch the ICs.
4. Whenever you uninstall any component, place it on a grounded anti-static pad or in the bag that comes with the component.
5. When placing screws into the screw holes to secure the motherboard to the chassis, please do not over-tighten the screws! Doing so may damage the motherboard.



Do not over-tighten the screws! Doing so may damage the motherboard.



Before you install or remove any component, ensure that the power is switched off or the power cord is detached from the power supply. Failure to do so may cause severe damage to the motherboard, peripherals, and/or components.

2.3 Installing the CPU and Heatsink



1. Before you insert the CPU into the socket, please check if the PnP cap is on the socket, if the CPU surface is unclean, or if there are any bent pins in the socket. Do not force to insert the CPU into the socket if above situation is found. Otherwise, the CPU will be seriously damaged.
2. Unplug all power cables before installing the CPU.

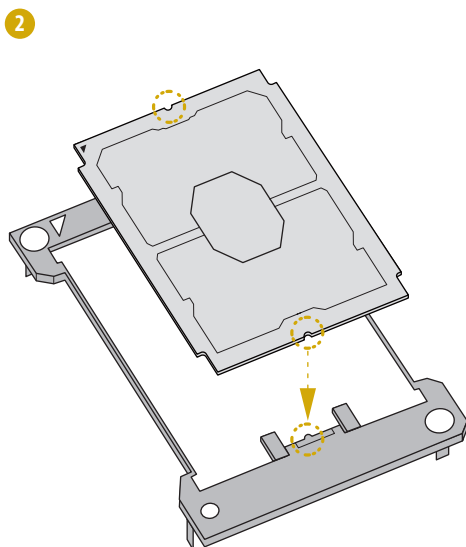
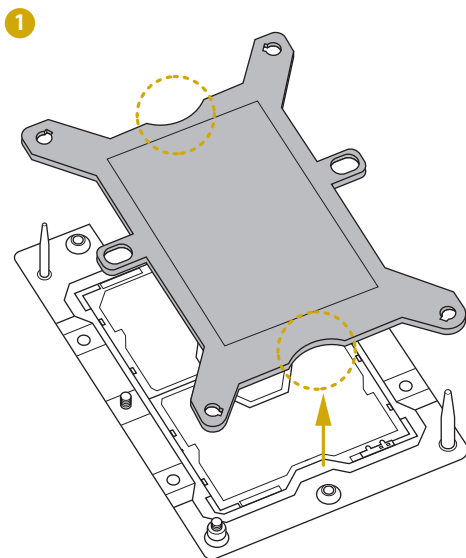



1. Before you installed the heatsink, you need to spray thermal interface material between the CPU and the heatsink to improve heat dissipation.
2. Illustration in this documentation are examples only. Heatsink or fan cooler type may differ.

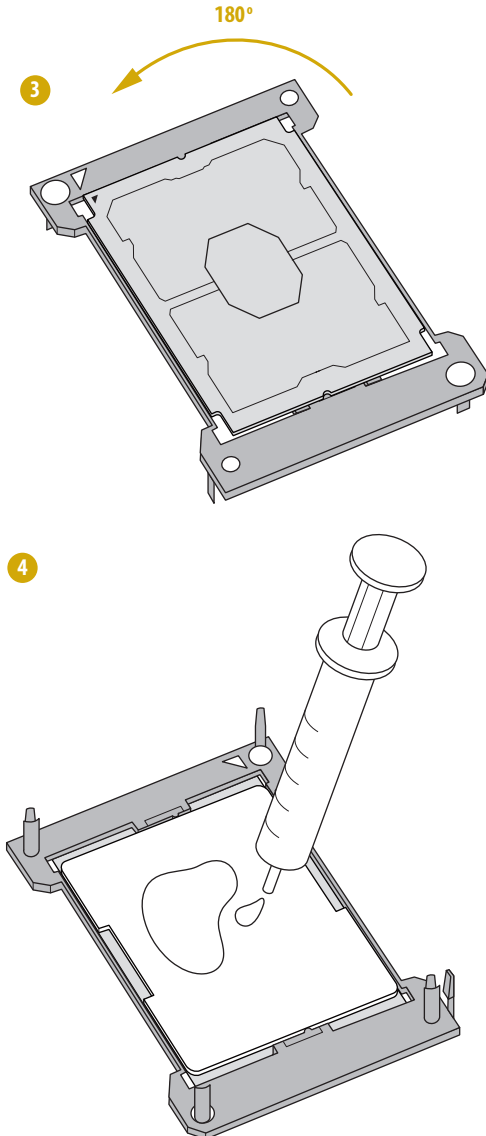

5

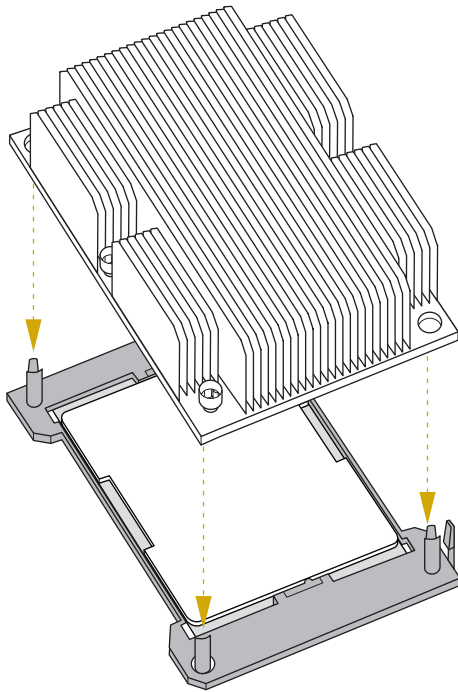

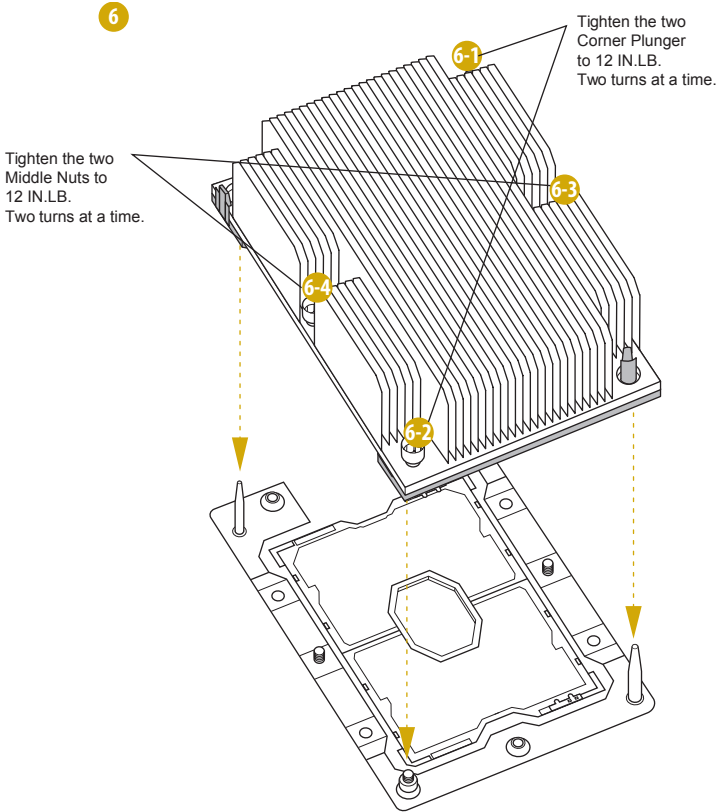

7

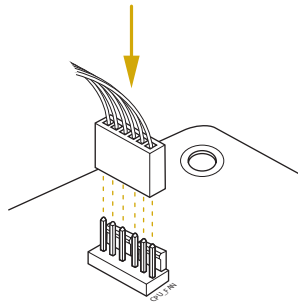

2.4 Installation of Memory Modules (DIMM)

This motherboard provides six 288-pin DDR4 (Double Data Rate 4) DIMM slots in two groups, and supports Six Channel Memory Technology.

1

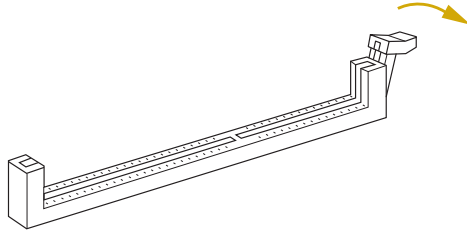

2

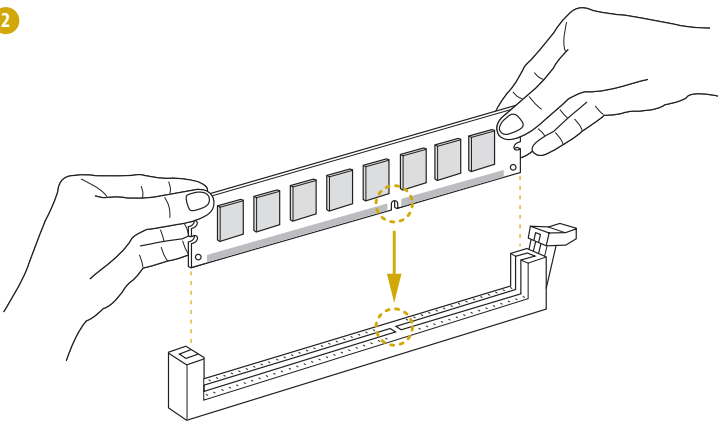

3

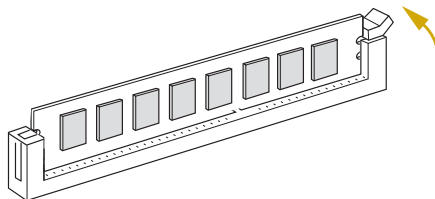

The DIMM only fits in one correct orientation. It will cause permanent damage to the motherboard and the DIMM if you force the DIMM into the slot in incorrect orientation.

2.5 Expansion Slots (PCI Express Slots)

There are 2 PCI Express slots on this motherboard.

PCIe slot:

PCIe4 (PCIe 3.0 x16 slot, from CPU1) is used for PCI Express x16 lane width cards.

PCIe6 (PCIe 3.0 x16 slot, from CPU1) is used for PCI Express x16 lane width cards.

| Slot | Generation | Mechanical | Electrical | Source |
|-------|------------|------------|------------|--------|
| PCIe6 | 3.0 | x16 | x16 | CPU1 |
| PCIe4 | 3.0 | x16 | x16 | CPU1 |

EPC621D6U-16R / EPC621D6U-2T16R only:

The SAS_NVMEA0_7 and SAS_NVMEB0_7 are shared with the PCIe4 slot. When PCIe4 is populated with a PCIe card, SAS_NVMEA0_7 and SAS_NVMEB0_7 are disabled.

Installing an expansion card

- Step 1. Before installing an expansion card, please make sure that the power supply is switched off or the power cord is unplugged. Please read the documentation of the expansion card and make necessary hardware settings for the card before you start the installation.
- Step 2. Remove the system unit cover (if your motherboard is already installed in a chassis).
- Step 3. Remove the bracket facing the slot that you intend to use. Keep the screws for later use.
- Step 4. Align the card connector with the slot and press firmly until the card is completely seated on the slot.
- Step 5. Fasten the card to the chassis with screws.
- Step 6. Replace the system cover.

2.6 Jumper Setup

The illustration shows how jumpers are setup. When the jumper cap is placed on the pins, the jumper is “Short”. If no jumper cap is placed on the pins, the jumper is “Open”. The illustration shows a 3-pin jumper whose pin1 and pin2 are “Short” when a jumper cap is placed on these 2 pins.

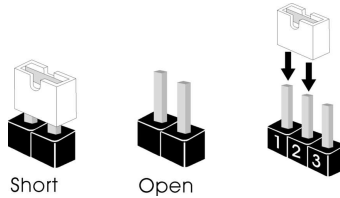

ME Recovery Jumper
(3-pin ME_RECOVERY1)
(see p.7, No. 32)



Normal Mode (Default)



ME Recovery Mode

Enable/Disable BMC Jumper¹
(3-pin BMC_DIS1)
(see p.7, No. 5)



Normal Mode (Default)
BMC Enabled



BMC Disabled

CPU Peci Mode Jumper
(3-pin Peci1)
(see p.7, No. 2)



CPU Peci connect to PCH



CPU Peci connect to BMC
(Default)







Flash Descriptor Security
Override Jumper
(3-pin J100)
(see p.7, No. 3)















Descriptor Security Over-
ride















Normal Mode (Default)

| | | |
|---|---|---|
| Chassis ID0 Jumper (3-pin CHASSIS_ID0) (see p.7, No. 4) | 1_2  | 1_2  |
| Chassis ID1 Jumper (3-pin CHASSIS_ID1) (see p.7, No. 6) | 1_2  | 1_2  |
| Chassis ID2 Jumper (3-pin CHASSIS_ID2) (see p.7, No. 7) | 1_2  | 2_3  |
| | Board Level SKU (Default) | Reserved for system level use |

| | | |
|---|---|---|
| Chassis ID0 Jumper (3-pin CHASSIS_ID0) (see p.7, No. 4) | 1_2  | 1_2  |
| Chassis ID1 Jumper (3-pin CHASSIS_ID1) (see p.7, No. 6) | 2_3  | 2_3  |
| Chassis ID2 Jumper (3-pin CHASSIS_ID2) (see p.7, No. 7) | 2_3  | 1_2  |
| | Reserved for system level use | Reserved for system level use |

| | | |
|---|---|---|
| Chassis ID0 Jumper (3-pin CHASSIS_ID0) (see p.7, No. 4) | 2_3  | 2_3  |
| Chassis ID1 Jumper (3-pin CHASSIS_ID1) (see p.7, No. 6) | 1_2  | 1_2  |
| Chassis ID2 Jumper (3-pin CHASSIS_ID2) (see p.7, No. 7) | 1_2  | 2_3  |
| | Reserved for system level use | Reserved for system level use |

| | | |
|--|--|--|
| Chassis ID0 Jumper (3-pin CHASSIS_ID0) (see p.7, No. 4) |  |  |
| Chassis ID1 Jumper (3-pin CHASSIS_ID1) (see p.7, No. 6) |  |  |
| Chassis ID2 Jumper (3-pin CHASSIS_ID2) (see p.7, No. 7) |  |  |
| | Reserved for system level use | Reserved for system level use |
| SATA DOM Power Jumper (3-pin SATAPWR1) (see p.7, No. 21) |  |  |
| | SATA DOM power 5V | SATA DOM power to GND (Default) |
| DIMM Mode Jumpers (3-pin AEP_1) (see p.7, No. 10) (3-pin AEP_2) (see p.7, No. 20) |  |  |
| | Normal Mode (Default) | NVDIMM Mode |
| EPC621D6U-16R / EPC621D6U-2T16R Only: | | |
| SATA/SAS and NVMe Mode Selection Jumpers (3-pin SAS_BP_1) (see p.7, No. 49) (3-pin SAS_CT_1) (see p.7, No. 48) |  |  |
| | NVMe Mode: Support 4*NVME HDD | SATA/SAS Mode: Support 16*SATA or SAS HDD |

2.7 Onboard Headers and Connectors



Onboard headers and connectors are NOT jumpers. Do NOT place jumper caps over these headers and connectors. Placing jumper caps over the headers and connectors will cause permanent damage to the motherboard.

System Panel Header
(9-pin PANEL1)
(see p.7, No. 36)

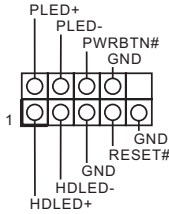

Connect the power switch, reset switch and system status indicator on the chassis to this header according to the pin assignments. Particularly note the positive and negative pins before connecting the cables.



PWRBTN (Power Switch):

Connect to the power switch on the chassis front panel. You may configure the way to turn off your system using the power switch.

RESET (Reset Switch):

Connect to the reset switch on the chassis front panel. Press the reset switch to restart the computer if the computer freezes and fails to perform a normal restart.

PLED (System Power LED):

Connect to the power status indicator on the chassis front panel. The LED is on when the system is operating. The LED is off when the system is in S4 sleep state or powered off (S5).

HDLED (Hard Drive Activity LED):

Connect to the hard drive activity LED on the chassis front panel. The LED is on when the hard drive is reading or writing data.

The front panel design may differ by chassis. A front panel module mainly consists of power switch, reset switch, power LED, hard drive activity LED, speaker and etc. When connecting your chassis front panel module to this header, make sure the wire assignments and the pin assignments are matched correctly.

Auxiliary Panel Header
(18-pin AUX_PANEL1)
(see p.7, No. 37)

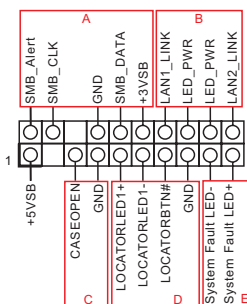

This header supports multiple functions on the front panel, including the front panel SMB, internet status indicator and chassis intrusion pin.



A. Front panel SMBus connecting pin (6-1 pin FPSMB)

This header allows you to connect SMBus (System Management Bus) equipment. It can be used for communication between peripheral equipment in the system, which has slower transmission rates, and power management equipment.

B. Internet status indicator (2-pin LAN1_LED, LAN2_LED)

These two 2-pin headers allow you to use the Gigabit internet indicator cable to connect to the LAN status indicator. When this indicator flickers, it means that the internet is properly connected.

C. Chassis intrusion pin (2-pin CHASSIS)

This header is provided for host computer chassis with chassis intrusion detection designs. In addition, it must also work with external detection equipment, such as a chassis intrusion detection sensor or a microswitch. When this function is activated, if any chassis component movement occurs, the sensor will immediately detect it and send a signal to this header, and the system will then record this chassis intrusion event. The default setting is set to the CASEOPEN and GND pin; this function is off.

D. Locator LED (4-pin LOCATOR)

This header is for the locator switch and LED on the front panel.

E. System Fault LED (2-pin LOCATOR)

This header is for the Fault LED on the system.

Serial ATA3 DOM
Connector
(SSATA_5)
(see p.7, No. 22)



The SATA3 DOM connector supports both a SATA DOM (Disk-On-Module) and a SATA data cable for internal storage device.

*The M.2 slot (M2_1) is shared with the SSATA_5 connector. When M2_1 is populated with a M.2 SATA3 module, SSATA_5 is disabled.

Serial ATA3 Connector
(SSATA_4)
(see p.7, No. 23)



The SATA3 connector supports SATA data cables for internal storage devices with up to 6.0 Gb/s data transfer rate.

Mini-SAS HD Connectors
(SATA_0_7)
(see p.7, No. 27)
(SSATA_0_3)
(see p.7, No. 28)

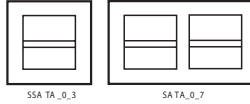

These connectors support MiniSAS-to-SATA data cables for internal storage devices with up to 6.0 Gb/s data transfer rate.

**EPC621D6U-16R /
EPC621D6U-2T16R
Only:**

Mini-SAS HD Connectors
(NVME)
(SAS_NVMEA0_7)
(see p.7, No. 47)
(SAS_NVMEB0_7)
(see p.7, No. 46)

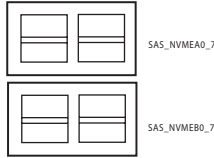

These connectors support MiniSAS-to SATA/SAS/NVMe data cable, 16 x SATA3 6.0 Gb/s or 12 x SAS 12 Gb/s or 4 x NVMe SSD (PCIe Gen 3.0)

**The SAS_NVMEA0_7 and SAS_NVMEB0_7 are shared with the PCIe4 slot. When PCIe4 is populated with a PCIe card, SAS_NVMEA0_7 and SAS_NVMEB0_7 are disabled.*

USB 3.0 Connector
(USB3_5)
(see p.7, No. 31)



USB 3.0 Header
(19-pin USB3_3_4)
(see p.7, No. 29)

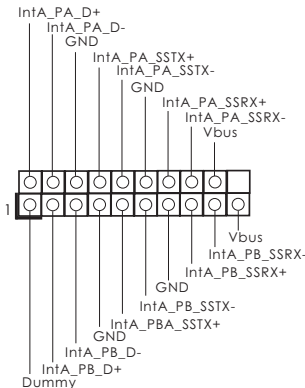

Besides two default USB 3.0 ports on the I/O panel, there is one USB 3.0 header on this motherboard. This USB 3.0 header can support two USB 3.0 ports.

USB 2.0 Header
(9-pin USB_1_2)
(see p.7, No. 30)

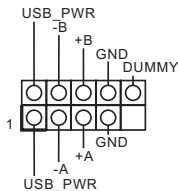

There is one USB 2.0 header on this motherboard. Each USB 2.0 header can support two ports.

Chassis Speaker Header
(4-pin SPEAKER1)
(see p.7, No. 26)



Please connect the chassis speaker to this header.

Non Maskable Interrupt
Button Header
(NMI_BTN1)
(see p.7, No. 40)



Please connect a NMI device to this header.

Front and Rear Fan Connectors
(6-pin FRNT_FAN1)
(see p.7, No. 15)
(6-pin FRNT_FAN2)
(see p.7, No. 16)
(6-pin FRNT_FAN3)
(see p.7, No. 18)
(6-pin FRNT_FAN4)
(see p.7, No. 19)
(6-pin REAR_FAN1)
(see p.7, No. 1)

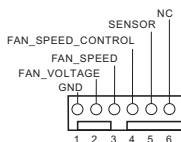

Please connect fan cables to the fan connectors and match the black wire to the ground pin. All fans support Fan Control.

CPU Fan Connector
(6-pin CPU1_FAN1)
(see p.7, No. 13)

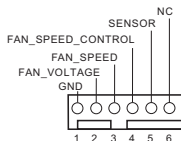

This motherboard provides one 6-Pin CPU fan (Quiet Fan) connector. If you plan to connect a 3-Pin CPU fan, please connect it to Pin 1-3.

**For more details, please refer to the Cooler QVL list on the ASRock Rack website.*

ATX Power Connector
(24-pin ATXPWR1)
(see p.7, No. 9)

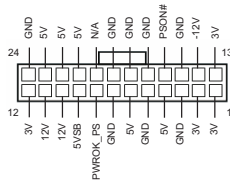

This motherboard provides a 24-pin ATX power connector. To use a 20-pin ATX power supply, please plug it along Pin 1 and Pin 13.

ATX 12V Power Connector
(8-pin ATX12V1)
(see p.7, No. 11)

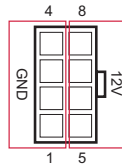

This motherboard provides one 8-pin ATX 12V power connector.

TPM Header
(17-pin TPM1)
(see p.7, No. 35)

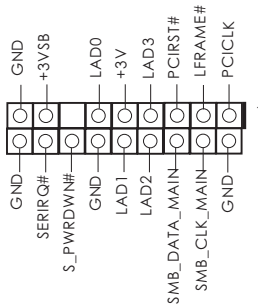

This connector supports Trusted Platform Module (TPM) system, which can securely store keys, digital certificates, passwords, and data. A TPM system also helps enhance network security, protects digital identities, and ensures platform integrity.

PSU SMBus Header
(5-pin PSU_SMB1)
(see p.7, No. 8)

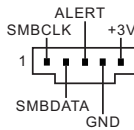

PSU SMBus monitors the status of the power supply, fan and system temperature.

Intelligent Platform Management Bus Header
(4-pin IPMB_1)
(see p.7, No. 39)

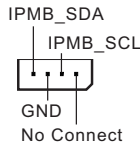

This 4-pin connector is used to provide a cabled base-board or front panel connection for value added features and 3rd-party add-in cards, such as Emergency Management cards, that provide management features using the IPMB.

Baseboard Management
Controller SMBus Header
(5-pin BMC_SMB_1)
(see p.7, No. 38)

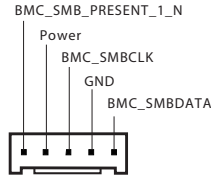

The header is used for the SM
BUS devices.

Thermal Sensor Header
(3-pin TR1)
(see p.7, No. 33)

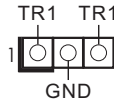

Please connect the thermal
sensor cable to either pin 1-2
or pin 2-3 and the other end to
the device which you wish to
monitor its temperature.

Serial General Purpose
Input/Output Header
(7-pin SSATA_SGPIO)
(see p.7, No. 24)

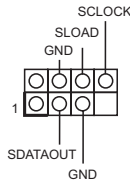

The header supports Serial
Link interface for onboard
SATA connections.

Serial Port Header
(9-pin COM1)
(see p.7, No. 41)

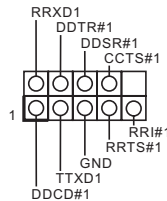

This COM header supports a
serial port module.

Slimline for U.2 x8
Connector
(SLIMLIN1)
(see p.7, No. 45)

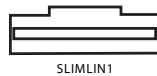

This connector is used for the
NVME PCIE devices.

Clear CMOS Pad
(CLRMOS1)
(see p.7, No. 25)



CLRMOS1 allows you to clear
the data in CMOS. To clear
CMOS, take out the CMOS
battery and short the Clear
CMOS Pad.

Virtual RAID On CPU
Header
(4-pin RAID_1)
(see p.7, No. 34)

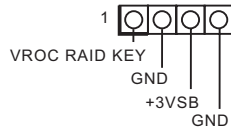

This connector supports Intel® Virtual RAID on CPU and NVME/AHCI RAID on CPU PCIE.

With the introduction of the Intel VROC product, there are three modes of operation:

| SKU | HW key required | Key features |
|-----------|-----------------|---|
| Pass-thru | Not needed | <ul style="list-style-type: none"> Pass-thru only (no RAID) LED Management Hot Plug Support RAID 0 support for Intel Fultondale NVMe SSDs |
| Standard | VROCSTANMOD | <ul style="list-style-type: none"> Pass-thru SKU features RAID 0, 1, 10 |
| Premium | VROCPREMMOD | <ul style="list-style-type: none"> Standard SKU features RAID 5 |
| ISS | VROCISSDMOD | <ul style="list-style-type: none"> RAID 5 Write Hole Closure |

*Only Intel SSDs are supported.

*For further details on VROC, please refer to the official information released by Intel.

2.8 Unit Identification purpose LED/Switch

With the UID button, You are able to locate the server you're working on from behind a rack of servers.

Unit Identification
purpose LED/Switch
(UID1)



When the UID button on the front or rear panel is pressed, the front/rear UID blue LED indicator will be turned on. Press the UID button again to turn off the indicator.

2.9 Driver Installation Guide

To install the drivers to your system, please insert the support CD to your optical drive first. Then, the drivers compatible to your system can be auto-detected and listed on the support CD driver page. Please follow the order from top to bottom to install those required drivers. Therefore, the drivers you install can work properly.

2.10 M.2_SSD (NGFF) Module Installation Guide

The M.2, also known as the Next Generation Form Factor (NGFF), is a small size and versatile card edge connector that aims to replace mPCIe and mSATA. The M.2_SSD (NGFF) Socket 3 can accommodate either a M.2 SATA3 6.0 Gb/s module or a M.2 PCI Express module up to Gen3 x4 (32 Gb/s).

**The M.2 slot (M2_1) is shared with the SSATA_5 connector. When M2_1 is populated with a M.2 SATA3 module, SSATA_5 is disabled.*

Installing the M.2_SSD (NGFF) Module

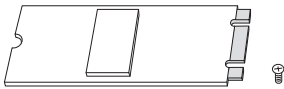

Step 1

Prepare a M.2_SSD (NGFF) module and the screw.

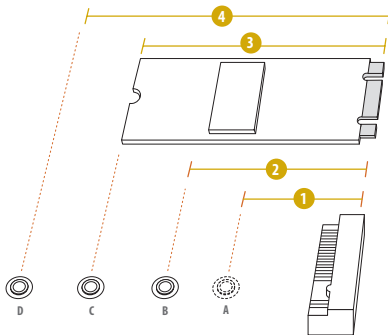

Step 2

Depending on the PCB type and length of your M.2_SSD (NGFF) module, find the corresponding nut location to be used.

| No. | 1 | 2 | 3 | 4 |
|--------------|----------|-----------|----------|-----------|
| Nut Location | A | B | C | D |
| PCB Length | 3cm | 4.2cm | 6cm | 8cm |
| Module Type | Type2230 | Type 2242 | Type2260 | Type 2280 |

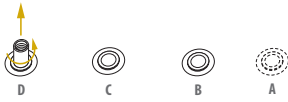

Step 3

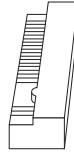

Move the standoff based on the module type and length. The standoff is placed at the nut location D by default. Skip Step 3 and 4 and go straight to Step 5 if you are going to use the default nut. Otherwise, release the standoff by hand.



Step 4

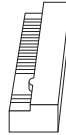

Peel off the yellow protective film on the nut to be used. Hand tighten the standoff into the desired nut location on the motherboard.

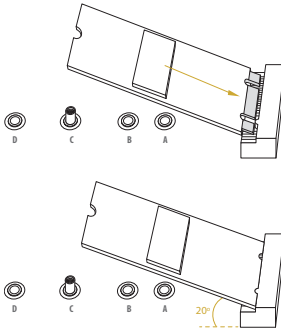

Step 5

Gently insert the M.2 (NGFF) SSD module into the M.2 slot. Please be aware that the M.2 (NGFF) SSD module only fits in one orientation.

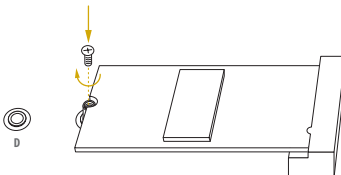

Step 6

Tighten the screw with a screwdriver to secure the module into place. Please do not overtighten the screw as this might damage the module.

For the latest updates of M.2_SSD (NFGG) module support list, please visit our website for details: <http://www.asrockrack.com>

Chapter 3 UEFI Setup Utility

3.1 Introduction

This section explains how to use the UEFI SETUP UTILITY to configure your system. The UEFI chip on the motherboard stores the UEFI SETUP UTILITY. You may run the UEFI SETUP UTILITY when you start up the computer. Please press <F2> or during the Power-On-Self-Test (POST) to enter the UEFI SETUP UTILITY; otherwise, POST will continue with its test routines.

If you wish to enter the UEFI SETUP UTILITY after POST, restart the system by pressing <Ctrl> + <Alt> + <Delete>, or by pressing the reset button on the system chassis. You may also restart by turning the system off and then back on.



Because the UEFI software is constantly being updated, the following UEFI setup screens and descriptions are for reference purpose only, and they may not exactly match what you see on your screen.

3.1.1 UEFI Menu Bar

The top of the screen has a menu bar with the following selections:

| Item | Description |
|-------------|---|
| Main | To set up the system time/date information |
| Advanced | To set up the advanced UEFI features |
| Security | To set up the security features |
| Boot | To set up the default system device to locate and load the Operating System |
| Event Logs | For event log configuration |
| Server Mgmt | To manage the server |
| Exit | To exit the current screen or the UEFI SETUP UTILITY |

Use <←→> key or <→←> key to choose among the selections on the menu bar, and then press <Enter> to get into the sub screen.

3.1.2 Navigation Keys

Please check the following table for the function description of each navigation key.

| Navigation Key(s) | Function Description |
|-------------------|--|
| ← / → | Moves cursor left or right to select Screens |
| ↑ / ↓ | Moves cursor up or down to select items |
| + / - | To change option for the selected items |
| <Tab> | Switch to next function |
| <Enter> | To bring up the selected screen |
| <PGUP> | Go to the previous page |
| <PGDN> | Go to the next page |
| <HOME> | Go to the top of the screen |
| <END> | Go to the bottom of the screen |
| <F1> | To display the General Help Screen |
| <F7> | Discard changes and exit the UEFI SETUP UTILITY |
| <F9> | Load optimal default values for all the settings |
| <F10> | Save changes and exit the UEFI SETUP UTILITY |
| <F12> | Print screen |
| <ESC> | Jump to the Exit Screen or exit the current screen |

3.2 Main Screen

Once you enter the UEFI SETUP UTILITY, the Main screen will appear and display the system overview. The Main screen provides system overview information and allows you to set the system time and date.

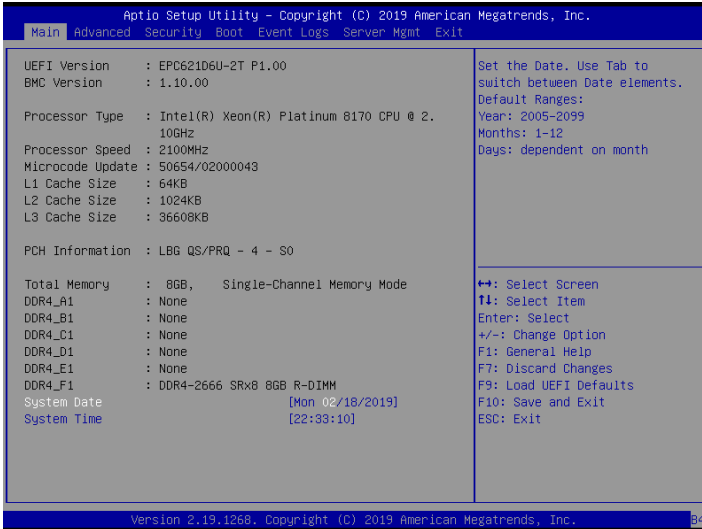

3.3 Advanced Screen

In this section, you may set the configurations for the following items: CPU Configuration, DRAM Configuration, Chipset Configuration, Storage Configuration, ACPI Configuration, USB Configuration, Super IO Configuration, Serial Port Console Redirection, H/W Monitor, Runtime Error Logging, Intel SPS Configuration, Intel® VMD Technology, Intel(R) Virtual RAID on CPU and Instant Flash.

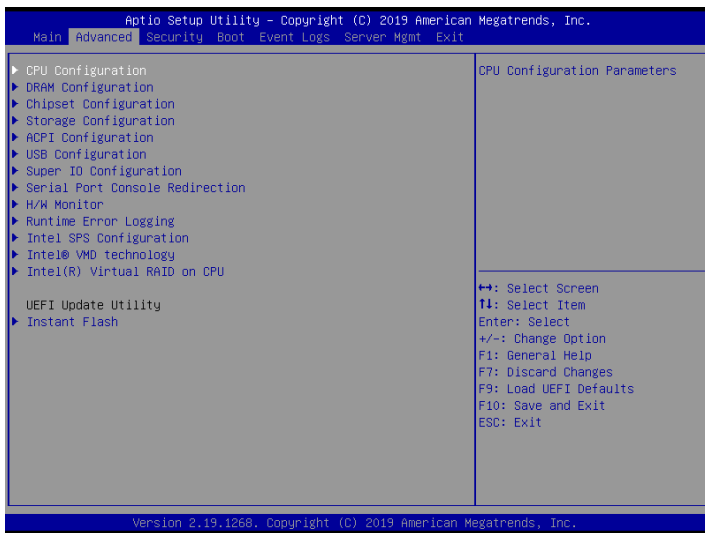

Setting wrong values in this section may cause the system to malfunction.

3.3.1 CPU Configuration

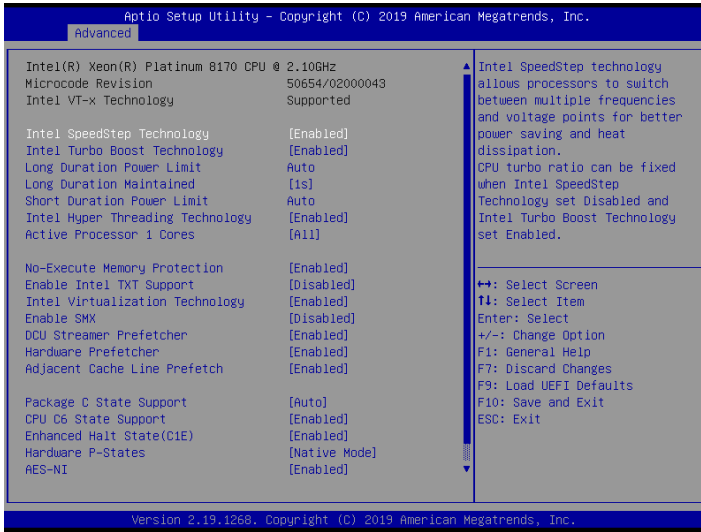

Intel SpeedStep Technology

Intel SpeedStep technology allows processors to switch between multiple frequencies and voltage points for better power saving and heat dissipation. CPU turbo ratio can be fixed when Intel SpeedStep Technology set Disabled and Intel Turbo Boost Technology set Enabled.



Please note that enabling this function may reduce CPU voltage and lead to system stability or compatibility issues with some power supplies. Please set this item to [Disabled] if above issues occur.

Intel Turbo Boost Technology

Intel Turbo Boost Technology enables the processor to run above its base operating frequency when the operating system requests the highest performance state.

Long Duration Power Limit

Configure Package Power Limit 1 in watts. When the limit is exceeded, the CPU ratio will be lowered after a period of time. A lower limit can protect the CPU and save power, while a higher limit may improve performance.

Long Duration Maintained

Configure the period of time until the CPU ratio is lowered when the Long Duration Power Limit is exceeded.

Short Duration Power Limit

Configure Package Power Limit 2 in watts. When the limit is exceeded, the CPU ratio will be lowered immediately. A lower limit can protect the CPU and save power, while a higher limit may improve performance.

Intel Hyper Threading Technology

Intel Hyper Threading Technology allows multiple threads to run on each core, so that the overall performance on threaded software is improved.

Active Processor 1 Cores

Select the number of cores to enable in each processor package.

No-Execute Memory Protection

Processors with No-Execution Memory Protection Technology may prevent certain classes of malicious buffer overflow attacks.

Enable Intel TXT Support

Enables Intel Trusted Execution Technology Configuration.

Intel Virtualization Technology

Intel Virtualization Technology allows a platform to run multiple operating systems and applications in independent partitions, so that one computer system can function as multiple virtual systems.

Enable SMX

Use this item to enable Safer Mode Extensions.

DCU Streamer Prefetcher

DCU streamer prefetcher is an L1 data cache prefetcher (MSR 1A4h [2]).

Hardware Prefetcher

Automatically prefetch data and code for the processor. Enable for better performance.

Adjacent Cache Line Prefetch

Automatically prefetch the subsequent cache line while retrieving the currently requested cache line. Enable for better performance.

Package C State Support

Enable CPU, PCIe, Memory, Graphics C State Support for power saving.

CPU C6 State Support

Enable C6 deep sleep state for lower power consumption.

Enhanced Halt State (C1E)

Enable Enhanced Halt State (C1E) for lower power consumption.

Hardware P-States

Disable: Hardware chooses a P-state based on OS Request (Legacy P-States)

Native Mode: Hardware chooses a P-state based on OS guidance

Out of Band Mode: Hardware autonomously chooses a P-state (no OS guidance)

AES-NI

Use this item to enable or disable AES-NI support.

CPU Thermal Throttling

Enable CPU internal thermal control mechanisms to keep the CPU from overheating.

3.3.2 DRAM Configuration

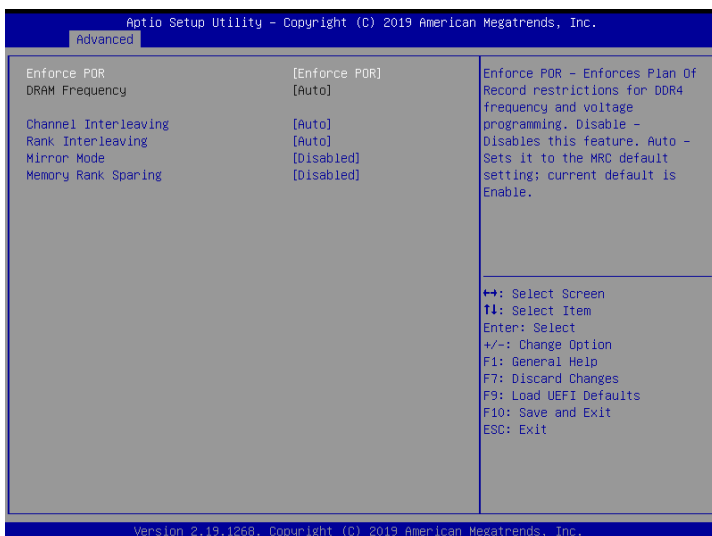

Enforce POR

Enable to enforce POR restrictions for DDR4 frequency and voltage programming.

DRAM Frequency

If [Auto] is selected, the motherboard will detect the memory module(s) inserted and assign the appropriate frequency automatically.

Channel Interleaving

Select to configure Channel Interleaving settings.

Rank Interleaving

Select to configure Rank Interleaving settings.

Mirror Mode

Mirror Mode will set entire 1LM/2LM memory in system to be mirrored, consequently reducing the memory capacity by half. Mirror Enable will disable XPT Prefetch.

Memory Rank Sparing

Enable or disable Memory Rank Sparing.

3.3.3 Chipset Configuration

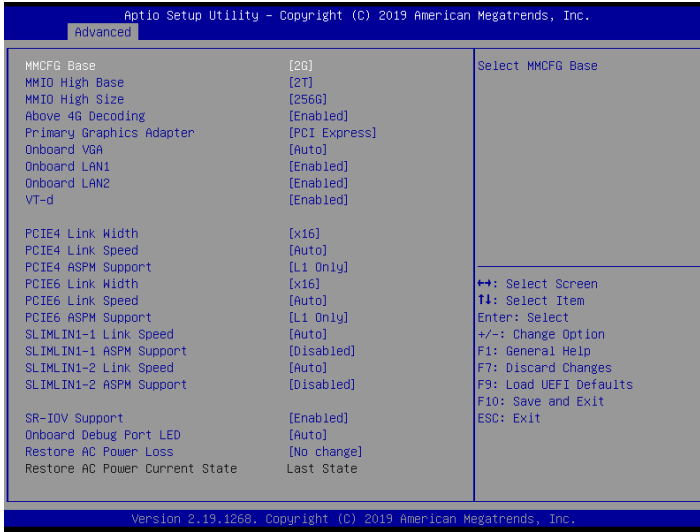

MMCFG Base

Use this item to select MMCFG Base.

MMIO High Base

Use this item to select MMIO High Base.

MMIO High Size

Use this item to select MMIO High Size.

Above 4G Decoding

Enable or disable 64bit capable Devices to be decoded in Above 4G Address Space (only if the system supports 64 bit PCI decoding).

Primary Graphics Adapter

If PCI Express graphics card is installed on the motherboard, you may use this option to select PCI Express or Onboard VGA as the primary graphics adapter.

**If no PCI Express graphics card is installed, [Onboard VGA] is the default graphics adapter. There is no screen on monitor even if a HDMI display is connected. Select [Onboard Hdmi] instead to use HDMI as output source.*

Onboard VGA

Use this to enable or disable the Onboard VGA function. The default value is [Auto].

**This item is not available when the Primary Graphic Adapter is set to [Onboard VGA].*

Onboard LAN 1 *(EPC621D6U-16R / EPC621D6U only)*

This allows you to enable or disable the Onboard LAN feature.

Onboard LAN 2 *(EPC621D6U-16R / EPC621D6U only)*

This allows you to enable or disable the Onboard LAN feature.

Onboard LAN *(EPC621D6U-2T16R / EPC621D6U-2T only)*

This allows you to enable or disable the Onboard LAN feature.

Onboard LSI3616 *(EPC621D6U-16R/EPC621D6U-2T16R only)*

This allows you to enable or disable the Onboard LSI3616 feature.

VT-d

Intel Virtualization Technology for Directed I/O helps your virtual machine monitor better utilize hardware by improving application compatibility and reliability, and providing additional levels of manageability, security, isolation, and I/O performance.

PCIE4 Link Width *(EPC621D6U / EPC621D6U-2T) /*

PCIE4/LSI3616 Link Width *(EPC621D6U-16R/EPC621D6U-2T16R)*

This allows you to select PCIE4/(LSI3616) Link Width. The default value is [x16].

PCIE4 Link Speed *(EPC621D6U / EPC621D6U-2T) /*

PCIE4/LSI3616 Link Speed *(EPC621D6U-16R/EPC621D6U-2T16R)*

This allows you to select PCIE4/(LSI3616) Link Speed. The default value is [Auto].

PCIE4 ASPM Support *(EPC621D6U / EPC621D6U-2T) /*

PCIE4/LSI3616 ASPM Support *(EPC621D6U-16R/EPC621D6U-2T16R)*

This option enables or disables the ASPM support for all CPU downstream devices.

PCIE6 Link Width

This allows you to select PCIE6 Link Width. The default value is [x16].

PCIE6 Link Speed

This allows you to select PCIE6 Link Speed. The default value is [Auto].

PCIE6 ASPM Support

This option enables or disables the ASPM support for all CPU downstream devices.

SLIMELIN1-1 Link Speed

This allows you to select SLIMLIN1-1 Link Speed. The default value is [Auto].

SLIMELIN1-1 ASPM Support

This option enables or disables the ASPM support for all CPU downstream devices.

SLIMELIN1-2 Link Speed

This allows you to select SLIMLIN1-2 Link Speed. The default value is [Auto].

SLIMELIN1-2 ASPM Support

This option enables or disables the ASPM support for all CPU downstream devices.

SR-IOV Support

If system has SR-IOV capable PCIe Devices, this option Enables or Disables Single Root IO Virtualization Support.

Onboard Debug Port LED

Enable/Disable the onboard Dr. Debug LED.

Restore AC Power Loss

This allows you to set the power state after a power failure. If [Power Off] is selected, the power will remain off when the power recovers. If [Power On] is selected, the system will start to boot up when the power recovers.

Restore AC Power Current State

This allows you to restore AC Power Current State.

3.3.4 Storage Configuration

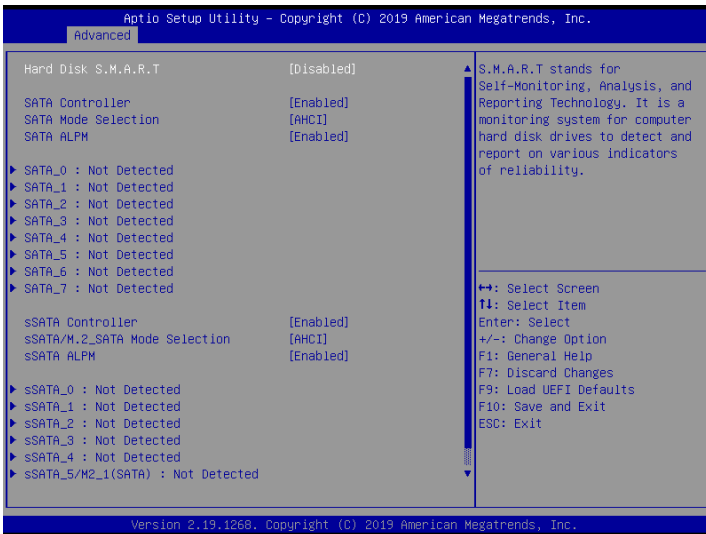

Hard Disk S.M.A.R.T.

Use this item to enable or disable the S.M.A.R.T. (Self-Monitoring, Analysis, and Reporting Technology) feature. Configuration options: [Disabled] and [Enabled].

SATA Controller

Use this item to enable or disable SATA Controllers.

SATA Mode Selection

Identify the SATA port is connected to Solid State Drive or Hard Disk Drive. Press <Ctrl+I> to enter RAID ROM during UEFI POST process.

SATA ALPM

Use this item to enable or disable SALP.

sSATA Storage Configuration

sSATA Controller

Use this item to enable or disable sSATA Controllers.

sSATA/M.2_SATA Mode Selection

Identify the sSATA port is connected to Solid State Drive or Hard Disk Drive. Press

<Ctrl+I> to enter RAID ROM during UEFI POST process.

sSATA ALPM

Use this item to enable or disable SALP.

3.3.5 ACPI Configuration

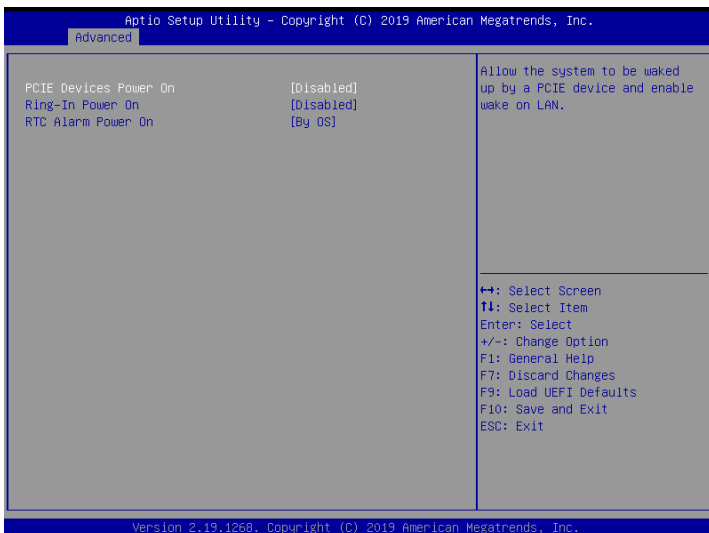

PCIE Devices Power On

Use this item to enable or disable PCIE devices to turn on the system from the power-soft-off mode.

Ring-In Power On

Use this item to enable or disable Ring-In signals to turn on the system from the power-soft-off mode.

RTC Alarm Power On

Use this item to enable or disable RTC (Real Time Clock) to power on the system.

3.3.6 USB Configuration

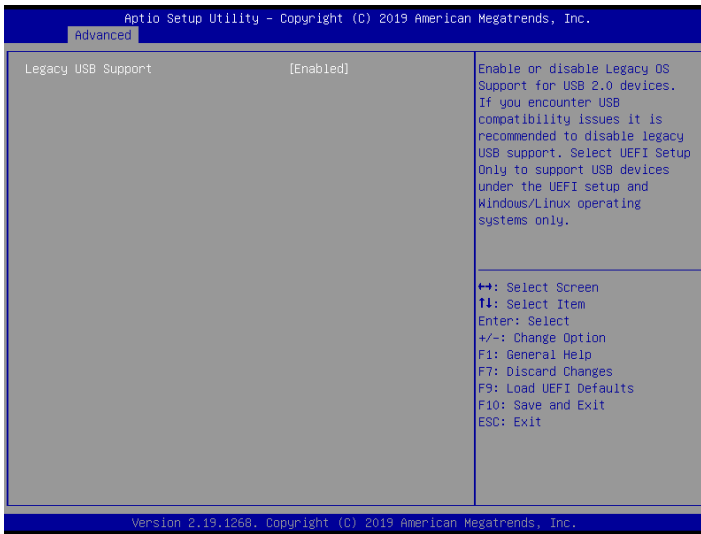

Legacy USB Support

Use this option to enable or disable legacy support for USB devices. The default value is [Enabled].

3.3.7 Super IO Configuration

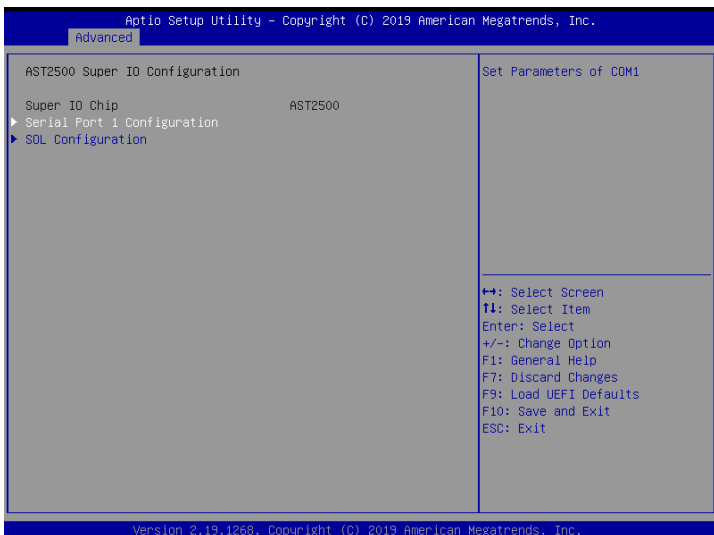

Serial Port 1 Configuration

Use this item to set parameters of Serial Port 1 (COM1).

Serial Port

Use this item to enable or disable the serial port.

Change Settings

Use this item to select an optimal setting for Super IO device.

SOL Configuration

Use this item to set parameters of SOL.

SOL Port

Use this item to set parameters of SOL.

Change Settings

Use this item to select an optimal setting for Super IO device.

3.3.8 Serial Port Console Redirection

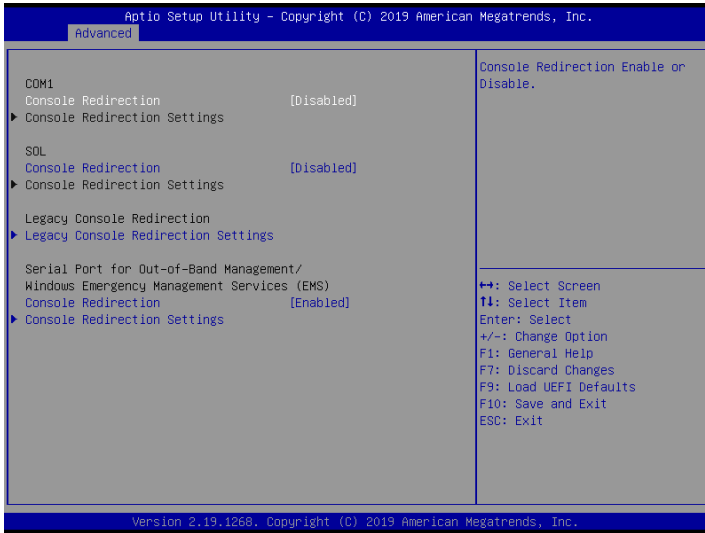

COM1 / SOL

Console Redirection

Use this option to enable or disable Console Redirection. If this item is set to Enabled, you can select a COM Port to be used for Console Redirection.

Console Redirection Settings

Use this option to configure Console Redirection Settings, and specify how your computer and the host computer to which you are connected exchange information. Both computers should have the same or compatible settings.

Terminal Type

Use this item to select the preferred terminal emulation type for out-of-band management. It is recommended to select [VT-UTF8].

| Option | Description |
|---------|---|
| VT100 | ASCII character set |
| VT100+ | Extended VT100 that supports color and function keys |
| VT-UTF8 | UTF8 encoding is used to map Unicode chars onto 1 or more bytes |
| ANSI | Extended ASCII character set |

Bits Per Second

Use this item to select the serial port transmission speed. The speed used in the host computer and the client computer must be the same. Long or noisy lines may require lower transmission speed. The options include [9600], [19200], [38400], [57600] and [115200].

Data Bits

Use this item to set the data transmission size. The options include [7] and [8] (Bits).

Parity

Use this item to select the parity bit. The options include [None], [Even], [Odd], [Mark] and [Space].

Stop Bits

The item indicates the end of a serial data packet. The standard setting is [1] Stop Bit. Select [2] Stop Bits for slower devices.

Flow Control

Use this item to set the flow control to prevent data loss from buffer overflow. When sending data, if the receiving buffers are full, a "stop" signal can be sent to stop the data flow. Once the buffers are empty, a "start" signal can be sent to restart the flow. Hardware flow uses two wires to send start/stop signals. The options include [None] and [Hardware RTS/CTS].

VT-UTF8 Combo Key Support

Use this item to enable or disable the VT-UTF8 Combo Key Support for ANSI/VT100 terminals.

Recorder Mode

Use this item to enable or disable Recorder Mode to capture terminal data and send it as text messages.

Resolution 100x31

Use this item to enable or disable extended terminal resolution support.

Legacy OS Redirection Resolution

Use this item to select the number of rows and columns used in legacy OS redirection.

Putty Keypad

Use this item to select Function Key and Keypad on Putty.

Redirection After BIOS POST

If the [LoadBooster] is selected, legacy console redirection is disabled before booting to legacy OS. If [Always Enabled] is selected, legacy console redirection is enabled for legacy OS. The default value is [Always Enabled].

Legacy Console Redirection

Legacy Console Redirection Settings

Use this option to configure Legacy Console Redirection Settings, and specify how your

computer and the host computer to which you are connected exchange information.

Legacy Serial Redirection Port

Use this item to select a COM port to display redirection of Legacy OS and Legacy OPRM Messages.

Serial Port for Out-of-Band Management/Windows Emergency Management Services (EMS)

Console Redirection

Use this option to enable or disable Console Redirection. If this item is set to Enabled, you can select a COM Port to be used for Console Redirection.

Console Redirection Settings

Use this option to configure Console Redirection Settings, and specify how your computer and the host computer to which you are connected exchange information.

Out-of-Band Mgmt Port

Microsoft Windows Emergency Management Services (EMS) allows for remote management of a Windows Server OS through a serial port.

Terminal Type

Use this item to select the preferred terminal emulation type for out-of-band management. It is recommended to select [VT-UTF8].

| Option | Description |
|---------|---|
| VT100 | ASCII character set |
| VT100+ | Extended VT100 that supports color and function keys |
| VT-UTF8 | UTF8 encoding is used to map Unicode chars onto 1 or more bytes |
| ANSI | Extended ASCII character set |

Bits Per Second

Use this item to select the serial port transmission speed. The speed used in the host computer and the client computer must be the same. Long or noisy lines may require lower transmission speed. The options include [9600], [19200], [57600] and [115200].

Flow Control

Use this item to set the flow control to prevent data loss from buffer overflow. When sending data, if the receiving buffers are full, a "stop" signal can be sent to stop the data flow. Once the buffers are empty, a "start" signal can be sent to restart the flow. Hardware flow uses two wires to send start/stop signals. The options include [None], [Hardware RTS/CTS], and [Software Xon/Xoff].

Data Bits

Parity

Stop Bits

3.3.9 H/W Monitor

In this section, it allows you to monitor the status of the hardware on your system, including the parameters of the CPU temperature, motherboard temperature, CPU fan speed, chassis fan speed, and the critical voltage.

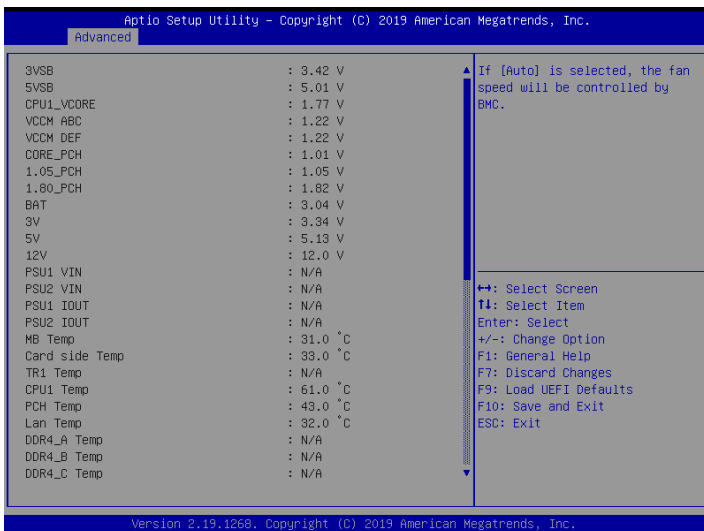

Fan Control

If [Auto] is selected, the fan speed will controlled by BMC.

If [Manual] is selected, configure the items below.

CPU1_FAN1

This allows you to set the CPU fan1's speed. The default value is [Smart Fan].

REAR_FAN 1

This allows you to set the rear fan 1's speed. The default value is [Smart Fan].

FRNT_FAN 1

This allows you to set the front fan 1's speed. The default value is [Smart Fan].

FRNT_FAN 2

This allows you to set the front fan 2's speed. The default value is [Smart Fan].

FRNT_FAN 3

This allows you to set the front fan 3's speed. The default value is [Smart Fan].

FRNT_FAN 4

This allows you to set the front fan 4's speed. The default value is [Smart Fan].

Smart Fan Control

This allows you to set the Smart fan's level speed.

Smart Fan Duty Control

Smart Fan Duty x (x means 1 to 11 stage)

This allows you to set duty cycle for each stage.

Smart Fan Temp Control

Smart Fan Temp x (x means 1 to 11 stage)

This allows you to set temperature for each stage.

Watch Dog Timer

This allows you to enable or disable the Watch Dog Timer. The default value is [Disabled].

3.3.10 Runtime Error Logging

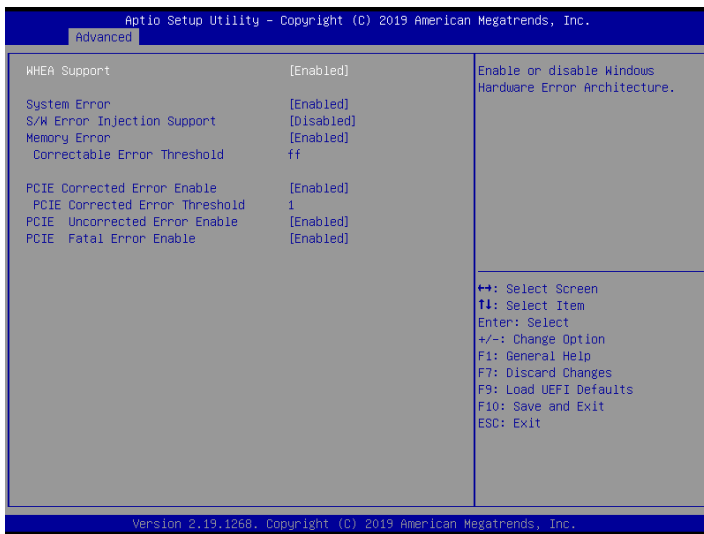

WHEA Support

Use this item to enable or disable Windows Hardware Error Architecture.

System Error

Use this item to enable or disable System Error feature. When it is set to [Enabled], you can configure Memory Error and PCIE Error log features.

S/W Error Injection Support

When it is set to [Enabled], S/W Error Injection is supported by unlocking MSR Ox790.

Memory Error

Memory enabling and logging setup option.

Correctable Error Threshold

Correctable Error Threshold (0 - 0x7FFF) used for sparing, tagging, and leaky bucket.

PCIE Corrected Error Enable

Use this item to enable or disable PCIE Correctable errors.

PCIE Corrected Error Threshold

PCIE Correctable Error Threshold (0x01-0xFF) used for sparing, tagging, and leaky bucket.

PCIe Uncorrected Error Enable

Use this item to enable or disable PCIe Uncorrectable errors.

PCIe Fatal Error Enable

Use this item to enable or disable PCIe Fatal errors.

3.3.11 Intel SPS Configuration

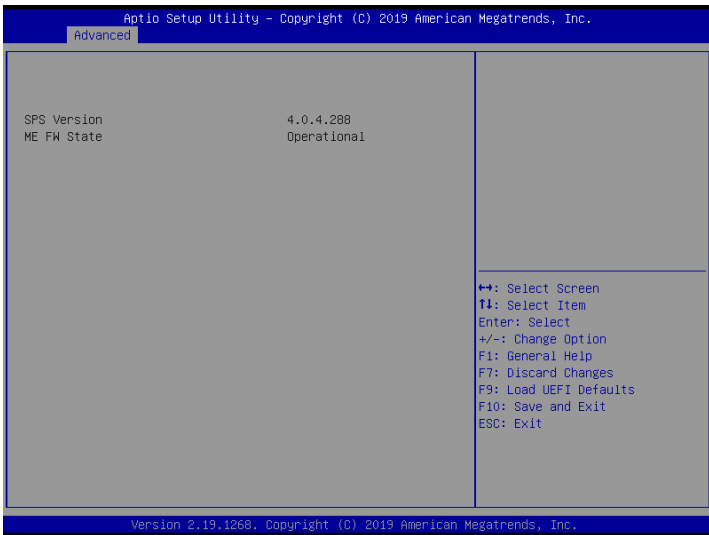

SPS screen displays the Intel SPS Configuration information, such as Operational Firmware Version and Firmware State.

3.3.12 Intel® VMD Technology

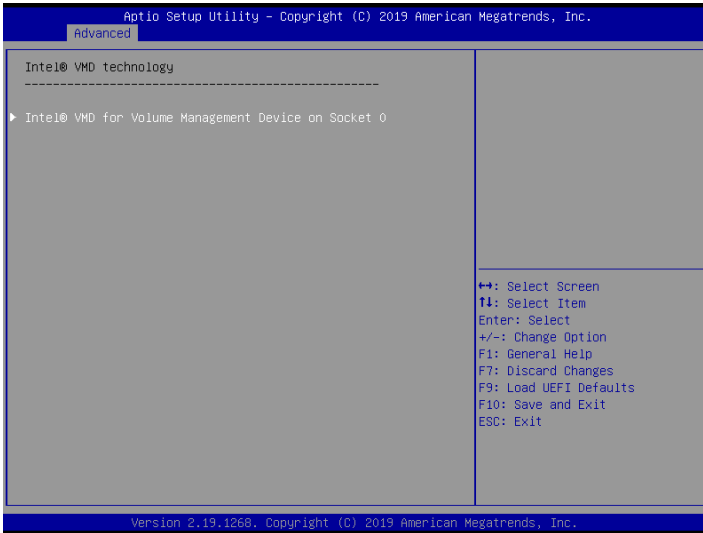

Intel® VMD for Volume Management Device on Socket 0

Intel® VMD for Volume Management Device for PStack0

Enable/Disable Intel® Volume Management Device Technology in this Stack.
When it is enabled, you will see the following items.

VMD port 1A

Enable/Disable Intel® Volume Management Device Technology on specific root port.

VMD port 1B

Enable/Disable Intel® Volume Management Device Technology on specific root port.

Hot Plug Capable

Enable/Disable Hot Plug for PCIe Root Ports 1A-1B.

Intel® VMD for Volume Management Device for PStack1

Enable/Disable Intel® Volume Management Device Technology in this Stack.
When it is enabled, you will see the following items.

VMD port 2A

Enable/Disable Intel® Volume Management Device Technology on specific root port.

VMD port 2B

Enable/Disable Intel® Volume Management Device Technology on specific root port.

VMD port 2C

Enable/Disable Intel® Volume Management Device Technology on specific root port.

VMD port 2D

Enable/Disable Intel® Volume Management Device Technology on specific root port.

Hot Plug Capable

Enable/Disable Hot Plug for PCIe Root Ports 2A-2D.

Intel® VMD for Volume Management Device for PStack2

Enable/Disable Intel® Volume Management Device Technology in this Stack.

When it is enabled, you will see the following items.

VMD port 3A

Enable/Disable Intel® Volume Management Device Technology on specific root port.

VMD port 3B

Enable/Disable Intel® Volume Management Device Technology on specific root port.

VMD port 3C

Enable/Disable Intel® Volume Management Device Technology on specific root port.

VMD port 3D

Enable/Disable Intel® Volume Management Device Technology on specific root port.

Hot Plug Capable

Enable/Disable Hot Plug for PCIe Root Ports 3A-3D.

3.3.13 Intel(R) Virtual RAID on CPU

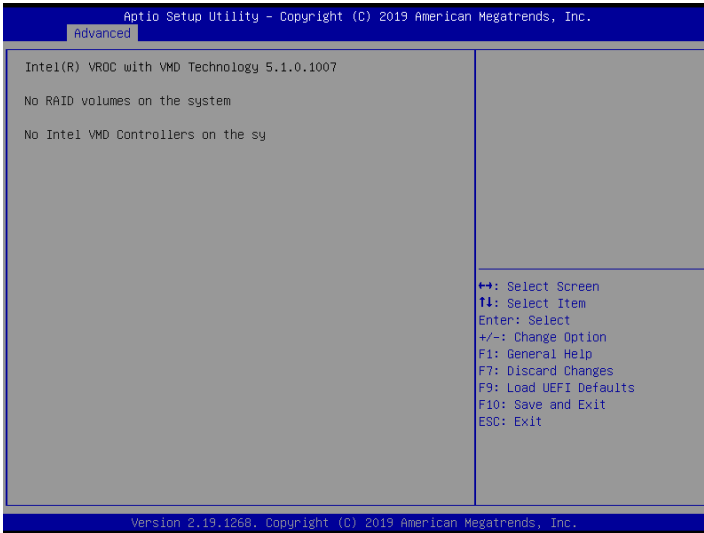

This formset allows the user to manage Intel(R) Virtual RAID on CPU.

3.3.14 Instant Flash

Instant Flash is a UEFI flash utility embedded in Flash ROM. This convenient UEFI update tool allows you to update system UEFI without entering operating systems first like MS-DOS or Windows. Just save the new UEFI file to your USB flash drive, floppy disk or hard drive and launch this tool, then you can update your UEFI only in a few clicks without preparing an additional floppy diskette or other complicated flash utility. Please be noted that the USB flash drive or hard drive must use FAT32/16/12 file system. If you execute Instant Flash utility, the utility will show the UEFI files and their respective information. Select the proper UEFI file to update your UEFI, and reboot your system after the UEFI update process is completed.

3.4 Security

In this section, you may set or change the supervisor/user password for the system. For the user password, you may also clear it.

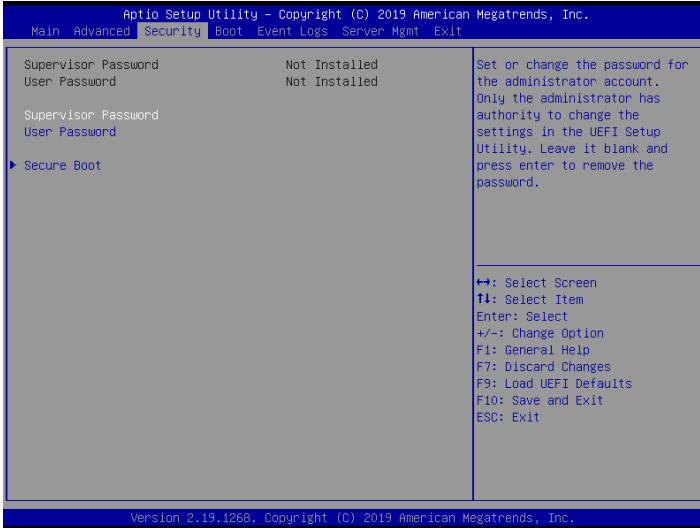

Supervisor Password

Set or change the password for the administrator account. Only the administrator has authority to change the settings in the UEFI Setup Utility. Leave it blank and press enter to remove the password.

User Password

Set or change the password for the user account. Users are unable to change the settings in the UEFI Setup Utility. Leave it blank and press enter to remove the password.

Secure Boot

Use this to enable or disable Secure Boot Control. The default value is [Disabled]. Enable to support Windows Server 2012 R2 or later versions Secure Boot.

Secure Boot Mode

Secure Boot mode selector: Standard/Custom. In Custom mode Secure Boot Variables can be configured without authentication.

3.4.1 Key Management

In this section, expert users can modify Secure Boot Policy variables without full authentication.

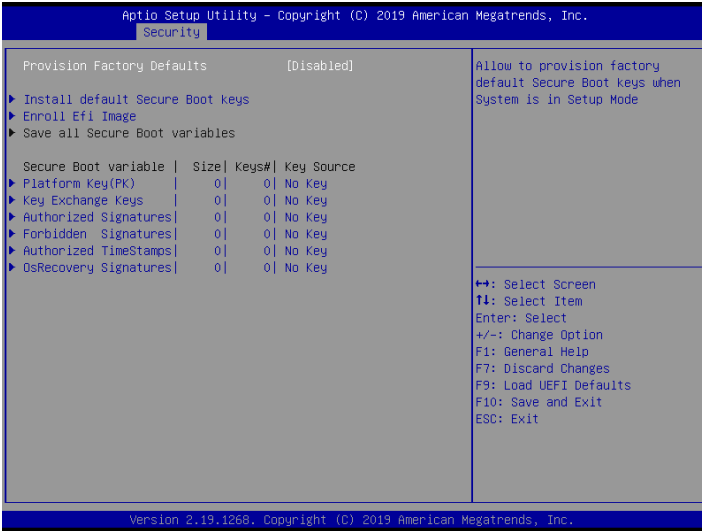

Provision Factory Defaults

Allow to provision factory default Secure Boot keys when System is in Setup Mode.

Install Default Secure Boot Keys

Please install default secure boot keys if it's the first time you use secure boot.

Enroll Efi Image

Allow the image to run in Secure Boot mode. Enroll SHA256 hash of the binary into Authorized Signature Database (db).

Platform Key(PK)

Enroll Factory Defaults or load certificates from a file:

1. Public Key Certificate in:

- EFI_SIGNATURE_LIST
- EFI_CERT_X509 (DER encoded)
- EFI_CERT_RSA2048 (bin)

d) EFI_CERT_SHA256, 384, 512

2. Authenticated UEFI Variable

3. EFI PE/COFF Image(SHA256)

Key Source: Default, External, Mixed, Test

Key Exchange Keys

Enroll Factory Defaults or load certificates from a file:

1. Public Key Certificate in:

a) EFI_SIGNATURE_LIST

b) EFI_CERT_X509 (DER encoded)

c) EFI_CERT_RSA2048 (bin)

d) EFI_CERT_SHA256, 384, 512

2. Authenticated UEFI Variable

3. EFI PE/COFF Image(SHA256)

Key Source: Default, External, Mixed, Test

Authorized Signatures

Enroll Factory Defaults or load certificates from a file:

1. Public Key Certificate in:

a) EFI_SIGNATURE_LIST

b) EFI_CERT_X509 (DER encoded)

c) EFI_CERT_RSA2048 (bin)

d) EFI_CERT_SHA256, 384, 512

2. Authenticated UEFI Variable

3. EFI PE/COFF Image(SHA256)

Key Source: Default, External, Mixed, Test

Forbidden Signatures

Enroll Factory Defaults or load certificates from a file:

1. Public Key Certificate in:

- a) EFI_SIGNATURE_LIST
 - b) EFI_CERT_X509 (DER encoded)
 - c) EFI_CERT_RSA2048 (bin)
 - d) EFI_CERT_SHA256, 384, 512
2. Authenticated UEFI Variable
 3. EFI PE/COFF Image(SHA256)

Key Source: Default, External, Mixed, Test

Authorized TimeStamps

Enroll Factory Defaults or load certificates from a file:

1. Public Key Certificate in:
 - a) EFI_SIGNATURE_LIST
 - b) EFI_CERT_X509 (DER encoded)
 - c) EFI_CERT_RSA2048 (bin)
 - d) EFI_CERT_SHA256, 384, 512
2. Authenticated UEFI Variable
3. EFI PE/COFF Image(SHA256)

Key Source: Default, External, Mixed, Test

OsRecovery Signatures

Enroll Factory Defaults or load certificates from a file:

1. Public Key Certificate in:
 - a) EFI_SIGNATURE_LIST
 - b) EFI_CERT_X509 (DER encoded)
 - c) EFI_CERT_RSA2048 (bin)
 - d) EFI_CERT_SHA256, 384, 512
2. Authenticated UEFI Variable
3. EFI PE/COFF Image(SHA256)

Key Source: Default, External, Mixed, Test

3.5 Boot Screen

In this section, it will display the available devices on your system for you to configure the boot settings and the boot priority.

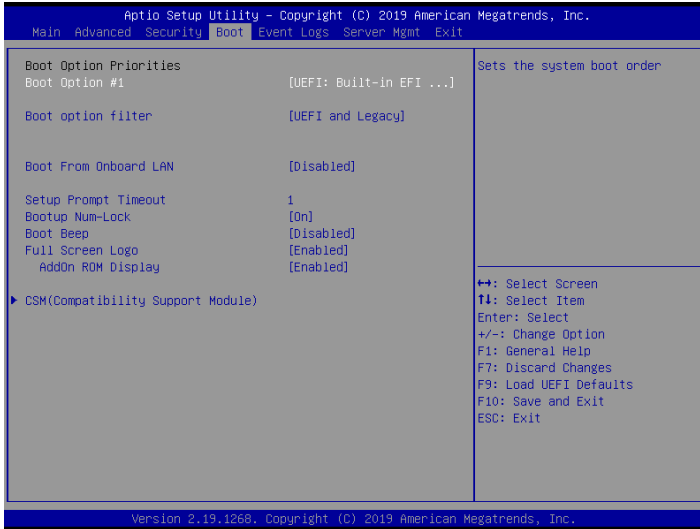

Boot Option #1

Use this item to set the system boot order.

Boot Option Filter

This option controls Legacy/UEFI ROMs priority.

Boot From Onboard LAN

Use this item to enable or disable the Boot From Onboard LAN feature.

Setup Prompt Timeout

Configure the number of seconds to wait for the UEFI setup utility.

Bootup Num-Lock

If this item is set to [On], it will automatically activate the Numeric Lock function after boot-up.

Boot Beep

Select whether the Boot Beep should be turned on or off when the system boots up. Please note that a buzzer is needed.

Full Screen Logo

Use this item to enable or disable OEM Logo. The default value is [Enabled].

AddOn ROM Display

Use this option to adjust AddOn ROM Display. If you enable the option “Full Screen Logo” but you want to see the AddOn ROM information when the system boots, please select [Enabled]. Configuration options: [Enabled] and [Disabled]. The default value is [Enabled].

3.5.1 CSM Parameters

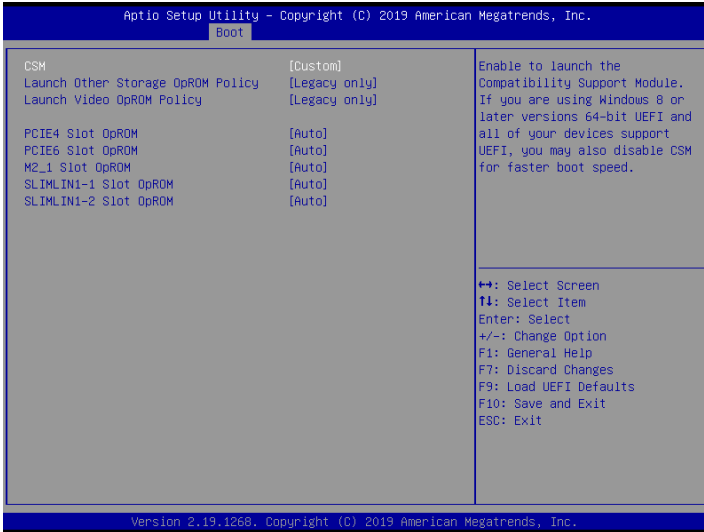

CSM

Enable to launch the Compatibility Support Module. Please do not disable unless you're running a WHCK test. If you are using Windows Server 2012 R2 or later versions 64-bit UEFI and all of your devices support UEFI, you may also disable CSM for faster boot speed.

Launch Other Storage OpROM Policy

Select UEFI only to run those that support UEFI option ROM only. Select Legacy only to run those that support legacy option ROM only. Select Do not launch to not execute both legacy and UEFI option ROM.

Launch Video OpROM Policy

Select UEFI only to run those that support UEFI option ROM only. Select Legacy only to run those that support legacy option ROM only. Select Do not launch to not execute both legacy and UEFI option ROM.

PCIE4 Slot OpROM (EPC621D6U / EPC621D6U-2T) /

PCIE4/LSI3616 Slot OpROM (EPC621D6U-16R/EPC621D6U-2T16R)

Use this item to select slot storage and Network Option ROM policy. In Auto option, the default is Disabled with NVMe device, but it is Legacy with other devices. (This item can't

select Video Option ROM policy.)

PCIE6 Slot OpROM

Use this item to select slot storage and Network Option ROM policy. In Auto option, the default is Disabled with NVMe device, but it is Legacy with other devices. (This item can't select Video Option ROM policy.)

M2_1 Slot OpROM

Use this item to select slot storage and Network Option ROM policy. In Auto option, the default is Disabled with NVMe device, but it is Legacy with other devices. (This item can't select Video Option ROM policy.)

SLIMLIN1-1 Slot OpROM

Use this item to select slot storage and Network Option ROM policy. In Auto option, the default is Disabled with NVMe device, but it is Legacy with other devices. (This item can't select Video Option ROM policy.)

SLIMLIN1-2 Slot OpROM

Use this item to select slot storage and Network Option ROM policy. In Auto option, the default is Disabled with NVMe device, but it is Legacy with other devices. (This item can't select Video Option ROM policy.)

3.6 Event Logs

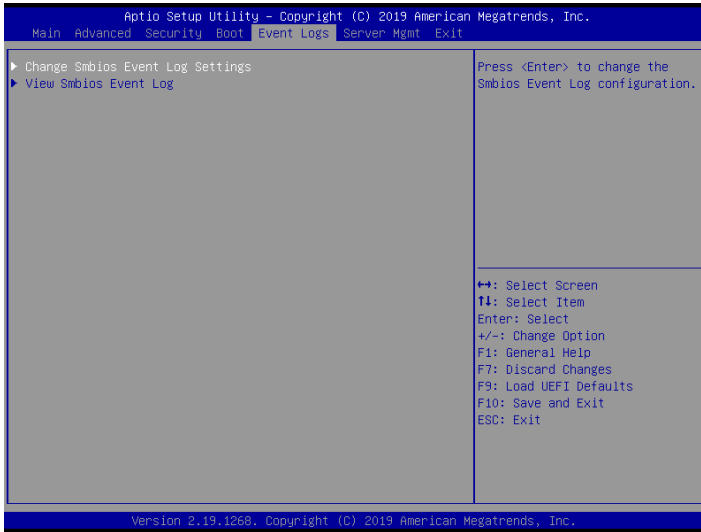

Change Smbios Event Log Settings

This allows you to configure the Smbios Event Log Settings.

When entering the item, you will see the followings:

Smbios Event Log

Use this item to enable or disable all features of the SMBIOS Event Logging during system boot.

Erase Event Log

The options include [No], [Yes, Next reset] and [Yes, Every reset]. If Yes is selected, all logged events will be erased.

When Log is Full

Use this item to choose options for reactions to a full Smbios Event Log. The options include [Do Nothing] and [Erase Immediately].

Log System Boot Event

Choose option to enable/disable logging of System boot event.

MECI (Multiple Event Count Increment)

Use this item to enter the increment value for the multiple event counter. The valid range is from 1 to 255.

METW (Multiple Event Time Window)

Use this item to specify the number of minutes which must pass between duplicate log

entries which utilize a multiple-event counter. The value ranges from 0 to 99 minutes.

View Smbios Event Log

Press <Enter> to view the Smbios Event Log records.



All values changed here do not take effect until computer is restarted.

3.7 Server Mgmt

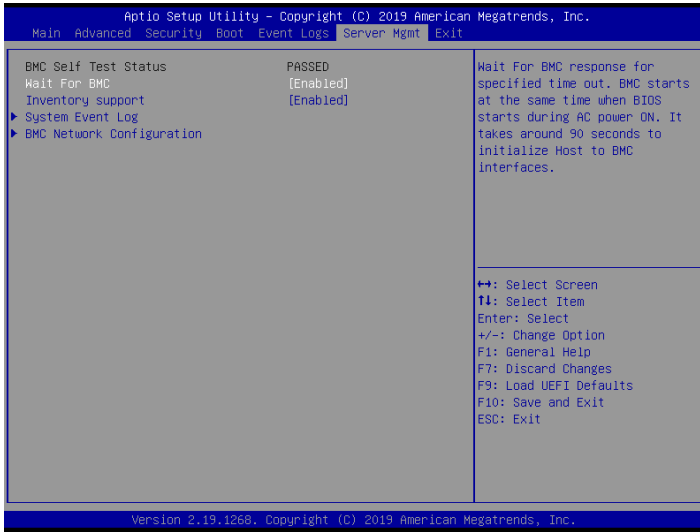

Wait For BMC

Wait For BMC response for specified time out. In PILOTII, BMC starts at the same time when BIOS starts during AC power ON. It takes around 90 seconds to initialize Host to BMC interfaces.

Inventory Support

This will execute inventory function for system. Enabling this item will take some time at system boot.

3.7.1 System Event Log

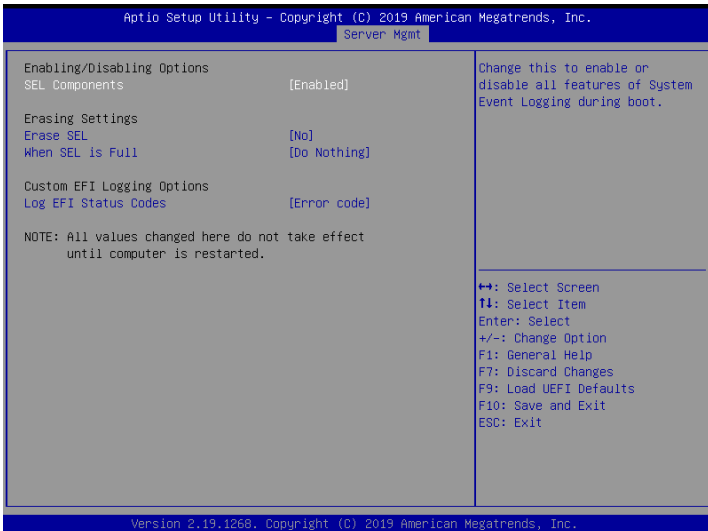

SEL Components

Change this to enable or disable all features of System Event Logging during boot.

Erase SEL

Use this to choose options for erasing SEL.

When SEL is Full

Use this to choose options for reactions to a full SEL.

Log EFI Status Codes

Use this item to disable the logging of EFI Status Codes or log only error code or only progress or both.

3.7.2 BMC Network Configuration

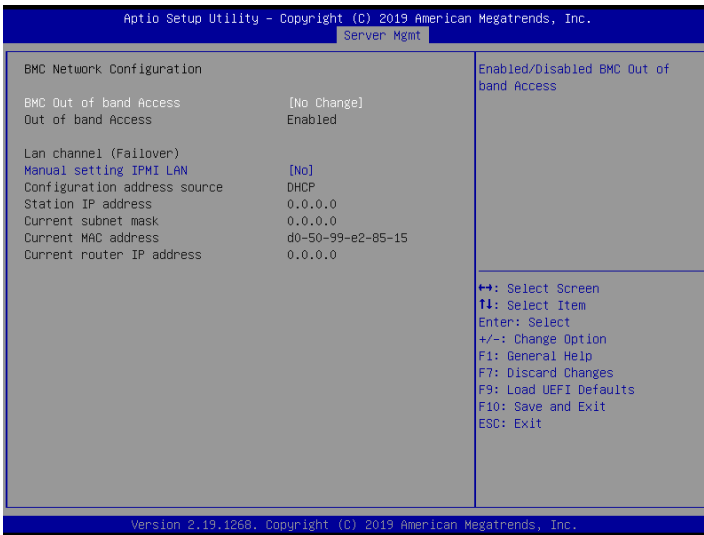

BMC Out of Band Access

Use this item to enable or disable BMC Out of Band Access.

Manual Setting IPMI LAN

If [No] is selected, the IP address is assigned by DHCP. If you prefer using a static IP address, toggle to [Yes], and the changes take effect after the system reboots. The default value is [No].

Configuration Address Source

Select to configure BMC network parameters statically or dynamically (by BIOS or BMC). Configuration options: [Static] and [DHCP].

Static: Manually enter the IP Address, Subnet Mask and Gateway Address in the BIOS for BMC LAN channel configuration.

DHCP: IP address, Subnet Mask and Gateway Address are automatically assigned by the network's DHCP server.



When [DHCP] or [Static] is selected, do NOT modify the BMC network settings on the IPMI web page.



The default login information for the IPMI web interface is:

Username: admin

Password: admin

For more instructions on how to set up remote control environment and use the IPMI management platform, please refer to the IPMI Configuration User Guide or go to the Support website at: <http://www.asrockrack.com/support/faq.asp>

3.8 Exit Screen

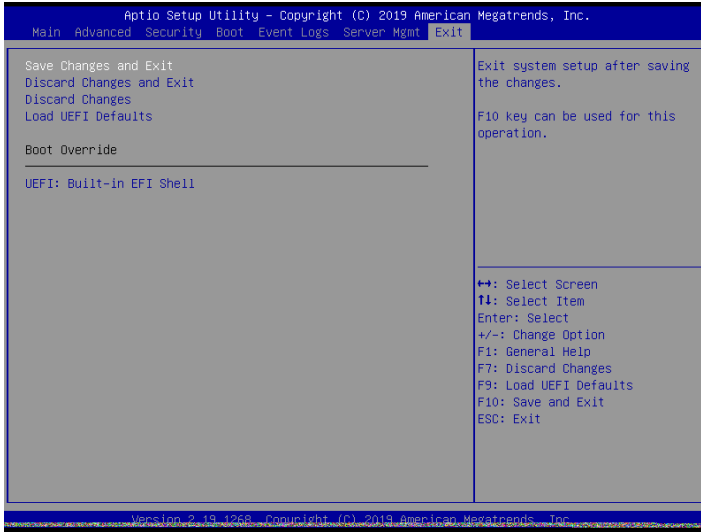

Save Changes and Exit

When you select this option, the following message “Save configuration changes and exit setup?” will pop-out. Press <F10> key or select [Yes] to save the changes and exit the UEFI SETUP UTILITY.

Discard Changes and Exit

When you select this option, the following message “Discard changes and exit setup?” will pop-out. Press <ESC> key or select [Yes] to exit the UEFI SETUP UTILITY without saving any changes.

Discard Changes

When you select this option, the following message “Discard changes?” will pop-out. Press <F7> key or select [Yes] to discard all changes.

Load UEFI Defaults

Load UEFI default values for all the setup questions. F9 key can be used for this operation.

Boot Override

These items displays the available devices. Select an item to start booting from the selected device.

Chapter 4 Software Support

4.1 Install Operating System

This motherboard supports various Microsoft® Windows® Server 2016 / 2012 R2 / Linux compliant. Because motherboard settings and hardware options vary, use the setup procedures in this chapter for general reference only. Refer to your OS documentation for more information.

**Please download the Intel® SATA Floppy Image driver from the ASRock Rack's website (www.asrockrack.com) to your USB drive or simply install the SATA driver from the Support CD while installing OS in SATA RAID mode.*

4.2 Support CD Information

The Support CD that came with the motherboard contains necessary drivers and useful utilities that enhance the motherboard's features.

4.2.1 Running The Support CD

To begin using the support CD, insert the CD into your CD-ROM drive. The CD automatically displays the Main Menu if "AUTORUN" is enabled in your computer. If the Main Menu does not appear automatically, locate and double click on the file "ASRSetup.exe" from the root folder in the Support CD to display the menu.

4.2.2 Drivers Menu

The Drivers Menu shows the available device's drivers if the system detects installed devices. Please install the necessary drivers to activate the devices.

4.2.3 Utilities Menu

The Utilities Menu shows the application softwares that the motherboard supports. Click on a specific item then follow the installation wizard to install it.

4.2.4 Contact Information

If you need to contact ASRock Rack or want to know more about ASRock Rack, welcome to visit ASRock Rack's website at <http://www.ASRockRack.com>; or you may contact your dealer for further information.

Chapter 5 Troubleshooting

5.1 Troubleshooting Procedures

Follow the procedures below to troubleshoot your system.



Always unplug the power cord before adding, removing or changing any hardware components. Failure to do so may cause physical injuries to you and damages to motherboard components.

1. Disconnect the power cable and check whether the PWR LED is off.
2. Unplug all cables, connectors and remove all add-on cards from the motherboard.
Make sure that the jumpers are set to default settings.
3. Confirm that there are no short circuits between the motherboard and the chassis.
4. Install a CPU and fan on the motherboard, then connect the chassis speaker and power LED.

If there is no power...

1. Confirm that there are no short circuits between the motherboard and the chassis.
2. Make sure that the jumpers are set to default settings.
3. Check the settings of the 115V/230V switch on the power supply.
4. Verify if the battery on the motherboard provides ~3VDC. Install a new battery if it does not.

If there is no video...

1. Try replugging the monitor cables and power cord.
2. Check for memory errors.

If there are memory errors...

1. Verify that the DIMM modules are properly seated in the slots.
2. Use recommended DDR4 RDIMM/LR DIMMs.
3. If you have installed more than one DIMM modules, they should be identical with the same brand, speed, size and chip-type.
4. Try inserting different DIMM modules into different slots to identify faulty ones.
5. Check the settings of the 115V/230V switch on the power supply.

Unable to save system setup configurations...

1. Verify if the battery on the motherboard provides ~3VDC. Install a new battery if it does not.
2. Confirm whether your power supply provides adequate and stable power.

Other problems...

1. Try searching keywords related to your problem on ASRock Rack's FAQ page:
<http://www.asrockrack.com/support>

5.2 Technical Support Procedures

If you have tried the troubleshooting procedures mentioned above and the problems are still unsolved, please contact ASRock Rack's technical support with the following information:

1. Your contact information
2. Model name, BIOS version and problem type.
3. System configuration.
4. Problem description.

You may contact ASRock Rack's technical support at:

<http://www.asrockrack.com/support/tsd.asp>

5.3 Returning Merchandise for Service

For warranty service, the receipt or a copy of your invoice marked with the date of purchase is required. By calling your vendor or going to our RMA website (<http://event.asrockrack.com/tsd.asp>) you may obtain a Returned Merchandise Authorization (RMA) number.

The RMA number should be displayed on the outside of the shipping carton which is mailed prepaid or hand-carried when you return the motherboard to the manufacturer. Shipping and handling charges will be applied for all orders that must be mailed when service is complete.

This warranty does not cover damages incurred in shipping or from failure due to alteration, misuse, abuse or improper maintenance of products.

Contact your distributor first for any product related problems during the warranty period.